



*...connecting to the aftermarket*

## **CT23MB26L**

**Mercedes E Class W212**

**2009 - 2012**

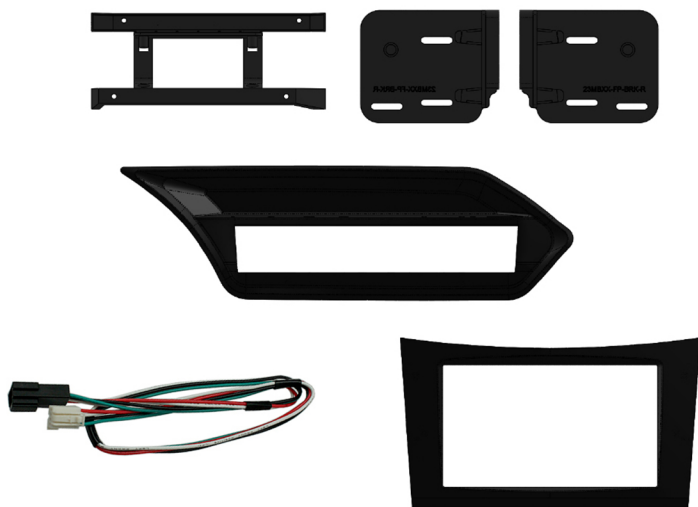

# **INSTRUCTION MANUAL**

# Kit Contents

Item Number	Description	Qty
1	Button Relocation Panel	1
2	Relocation Panel Bracket	1
3	Button Retention	1
4	Button Retention	1
5	Fascia Panel	1
6	Stereo Bracket Left	1
7	Stereo Bracket Right	1
8	1/4" Self tapping	2
9	M5 Screws 8mm	4
10	3/8" Self Tapping	6

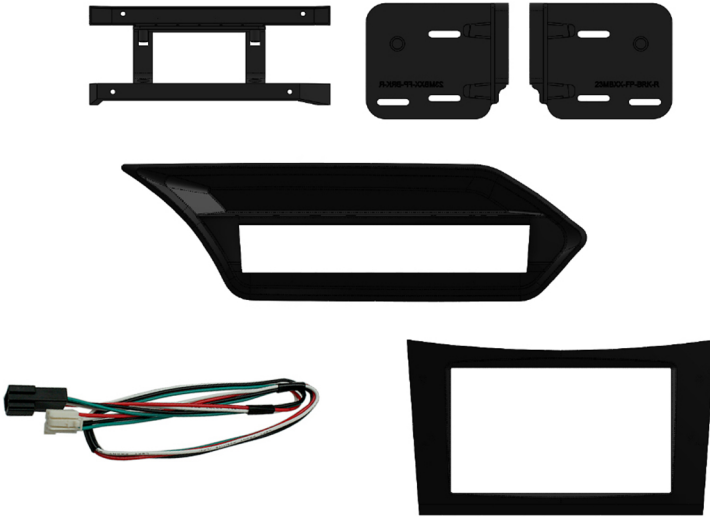

# FITTING GUIDE

1. Using a plastic removal tool, remove the air vent panel. Lever the clip out inside the air vents as shown in the right hand side image below.

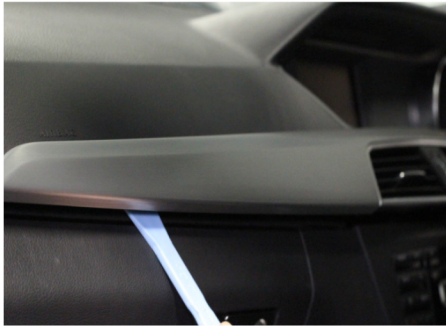

2. When removing the air vent panel, unplug the blue connector to the air vent controls.

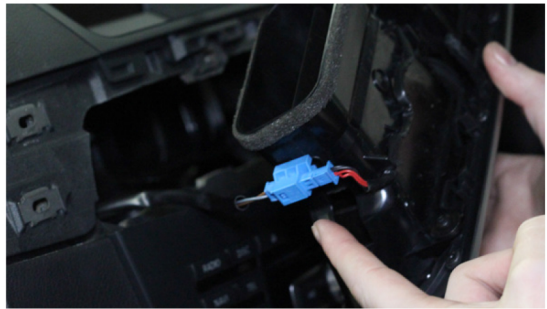

3. Unscrew x2 screws on top of the head unit making sure you only unscrew the screws half way then push the screws down. This will unlock the OEM head unit bracket assembly.



4. Remove the head unit and unplug all connectors attached, including the connector attached to the fascia panel of the head unit.



5. Remove OEM plastic screen frame pictured below.



6. Connect the black connector of the supplied button relocation extension cable to the white OEM connector that was unplugged from the head unit's fascia panel in step 4. Feed the cable up through the dash so the white connector can plug into the button panel shown in step 6.



7. Mount the supplied facia panel brackets (Left and Right) to the aftermarket head unit.

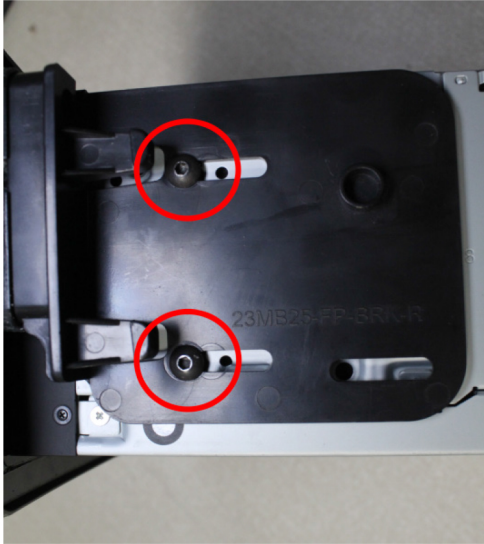

8. Insert the head unit and wiring assembly into the dash. The head unit is slotted into place via the guide rails as the reverse of step 3. Test the head unit for correct operation and move on to button relocation panel assembly

9. Assemble the button relocation panel as shown in the diagram below.

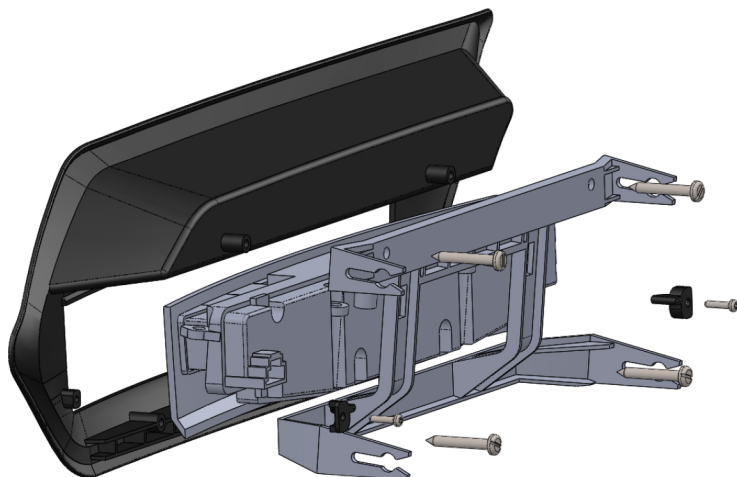

Insert the buttons into the relocation panel. Insert below the top lip and click into place. ScREW the relocation bracket to the panel using the four holes on the back.

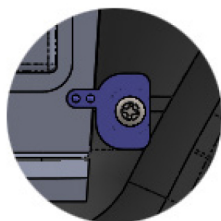
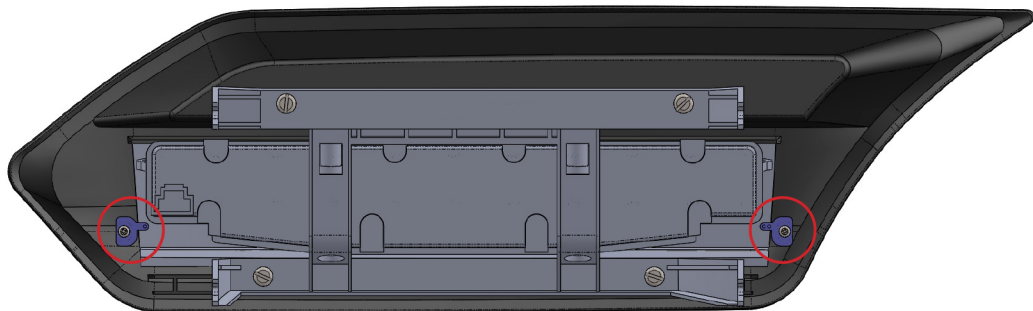

Screw the small plastic brackets circled into place. The bracket with two dots should be fitted to the side closest to the steering wheel as pictured.

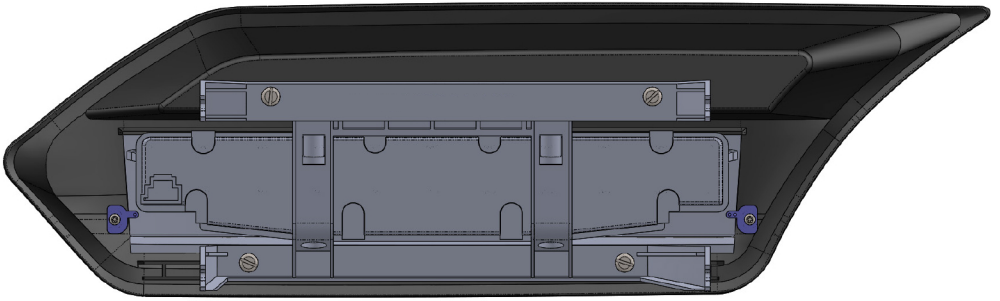

Screw the final two screws into the bottom of the bracket as circled.

Once this is done re connect the OEM connector and test. Once everything is working insert the button relocation panel back into the dash. This should clip into place.

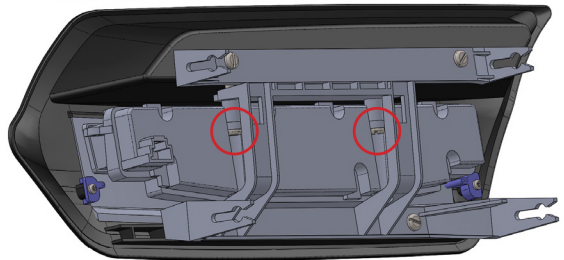

**10.** Installation is now complete.

