

Guide de montage d'un système de navigation dans une Volkswagen Golf VII



Pièces Pioneer

Kit de montage réf : CA-HM-VAG.003



Interface démultiplexage réf : CA-R-VAG.001



Kit double USB + Aux réf : CA-IW-VAG.002V



Dépose de l'autoradio d'origine

Mesures de sécurité



Avant toute intervention sur le véhicule!!!

- Contrôler la tension de courant du véhicule **+/- 12 V**.
- Le pôle **négatif** de la batterie à la **carrosserie**.
- Afin d'éviter tout risque de court-circuit et de réinitialisation du système électrique du véhicule, **débrancher le câble** de la borne négative de la batterie avant de commencer la pose.



Dépose des éléments d'origine

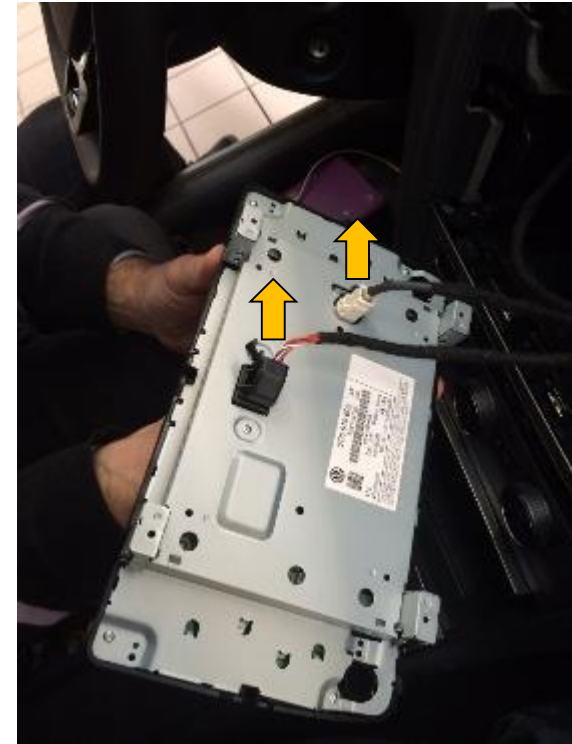
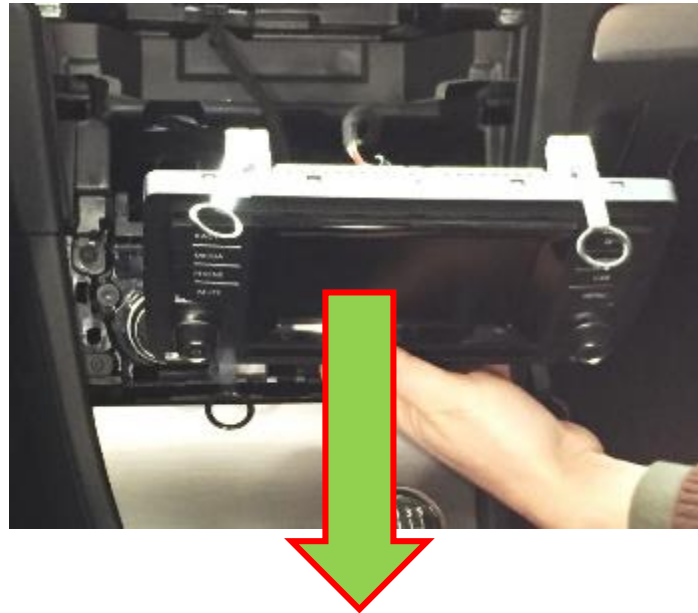
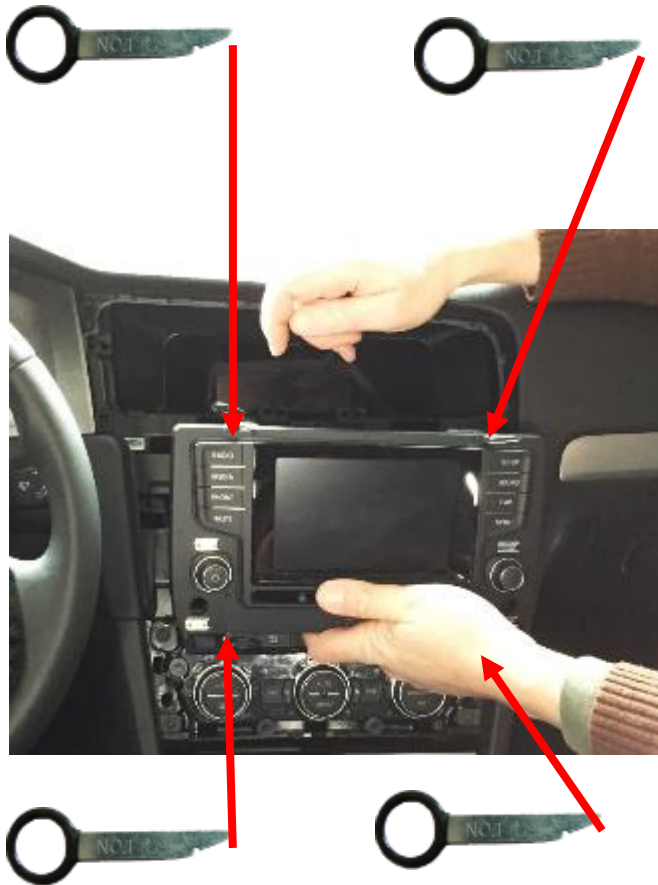

Dépose des éléments d'origine

Déposez le lecteur de CD

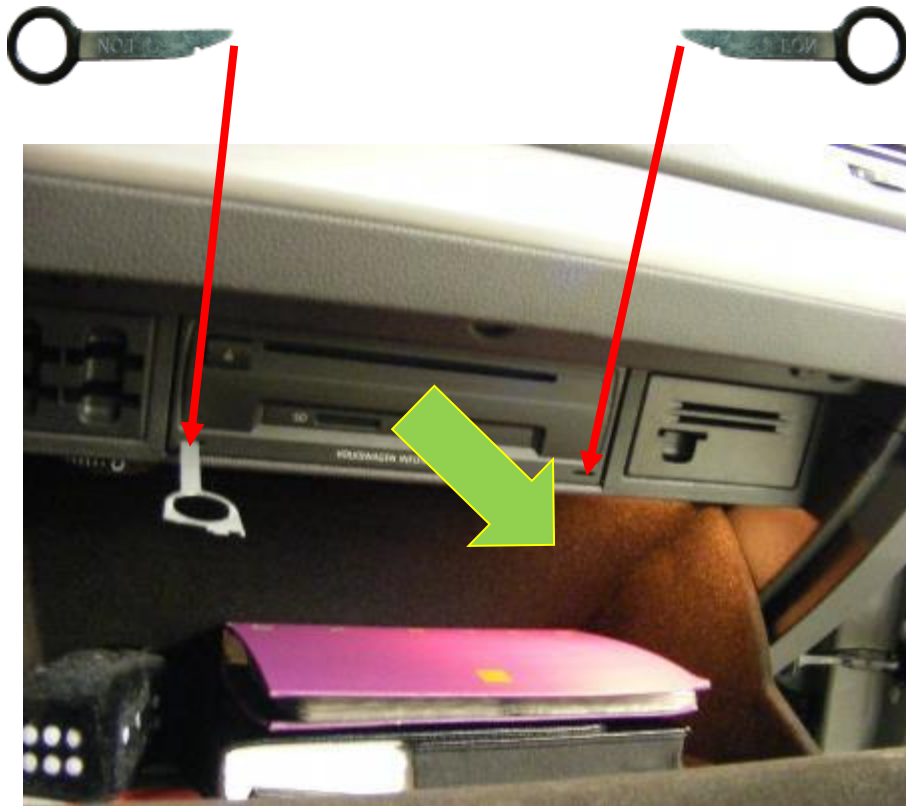

Dépose de la boîte à gants

Situation des vis pour la dépose de la boîte à gants

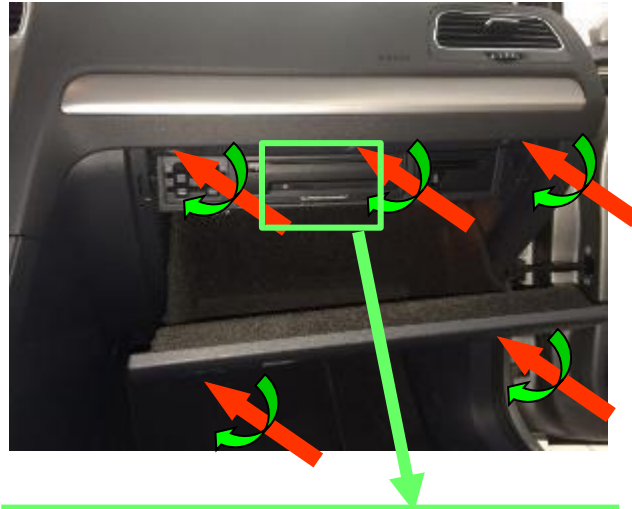

*Dévissez les vis qui
maintiennent la
boîte à gants.
Attention: ne pas
oublier la vis
derrière le lecteur de
CD.*

Préparation pour l'intégration du système.

Découpez la partie plastique avec une scie à main en suivant les pointillés.

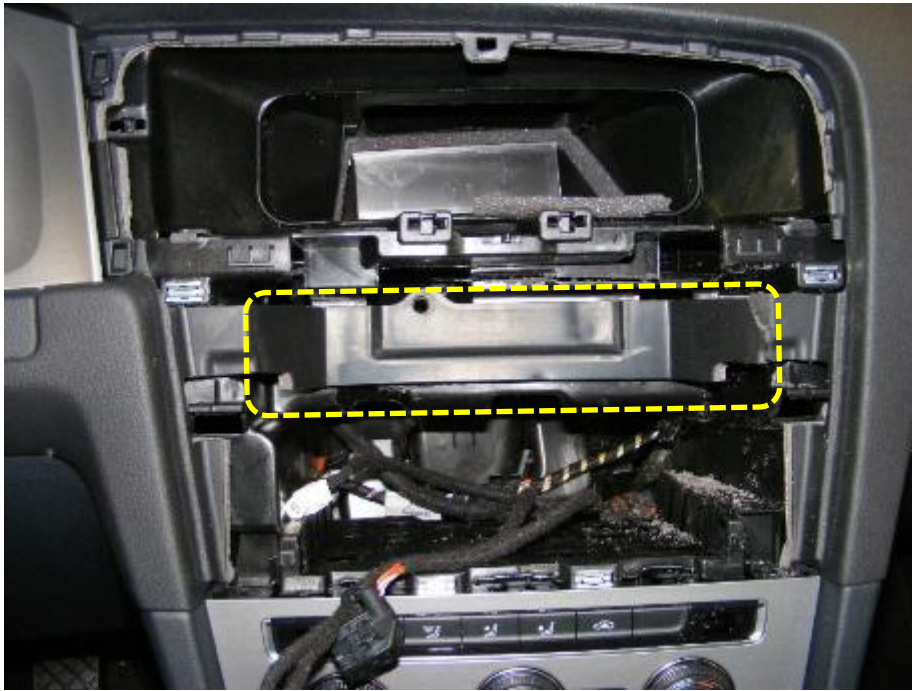

Interface USB.

Sortez le vide-poche puis changez le support USB.

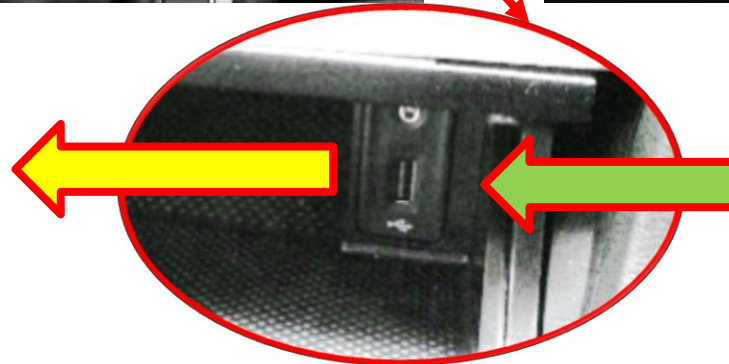

Installation de l'antenne GPS.

Posez l'antenne GPS avec la plaque métallique sur la traverse métallique.

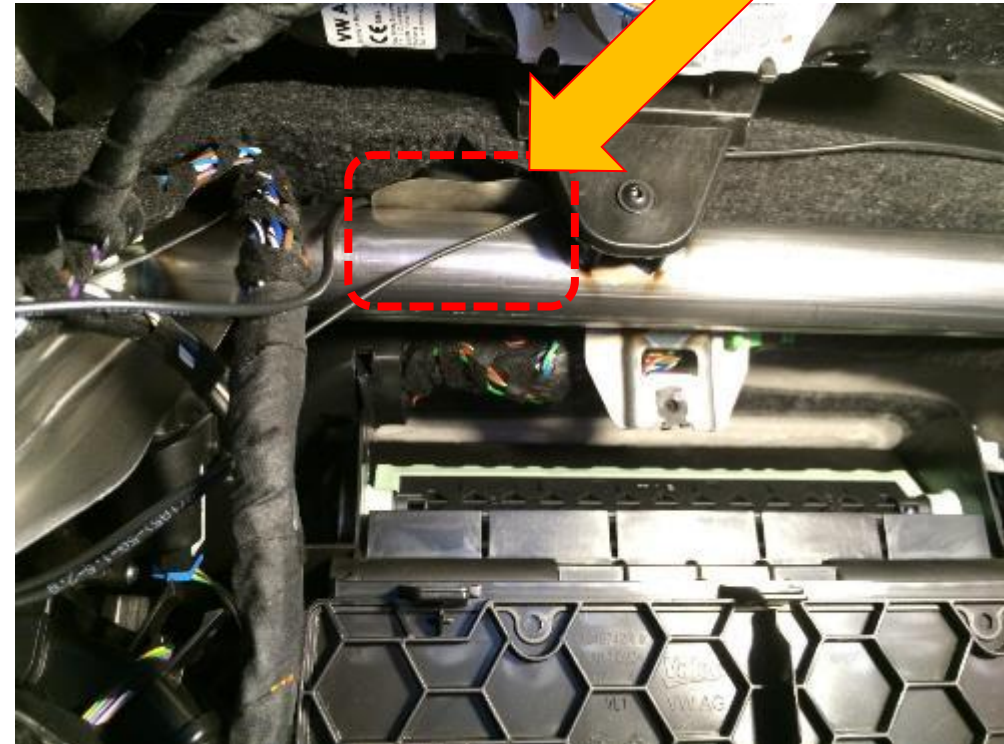
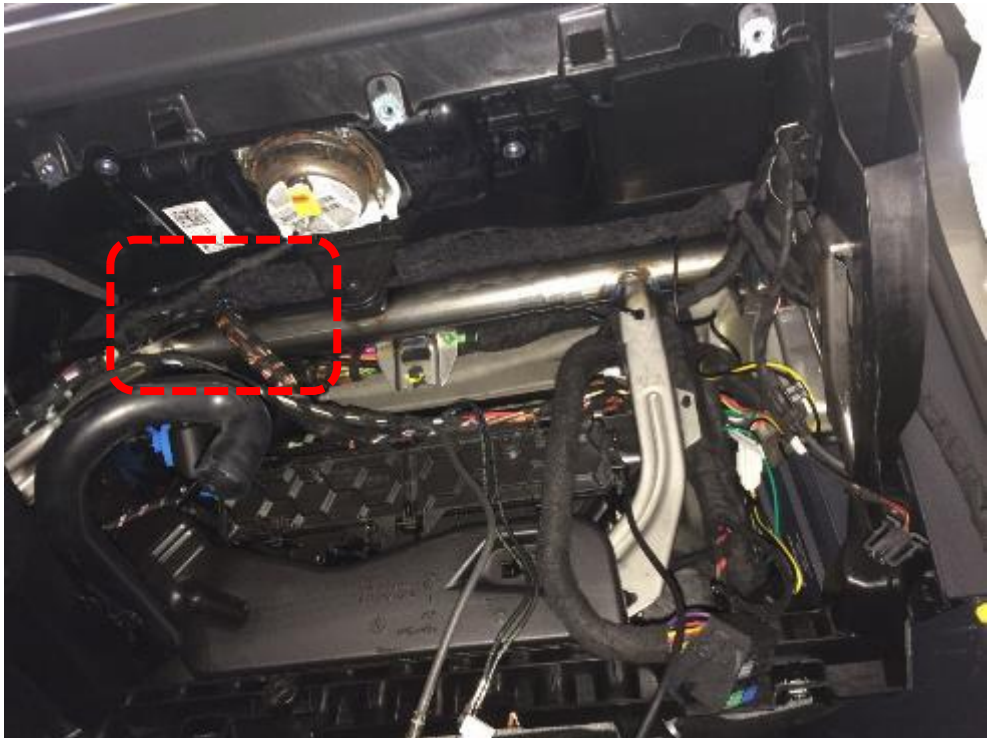
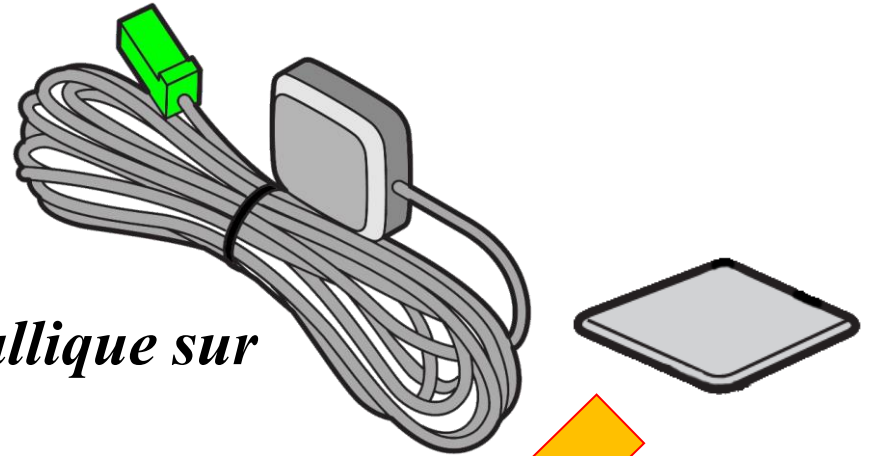

Emplacement de l'interface et du connecteur FAKRA

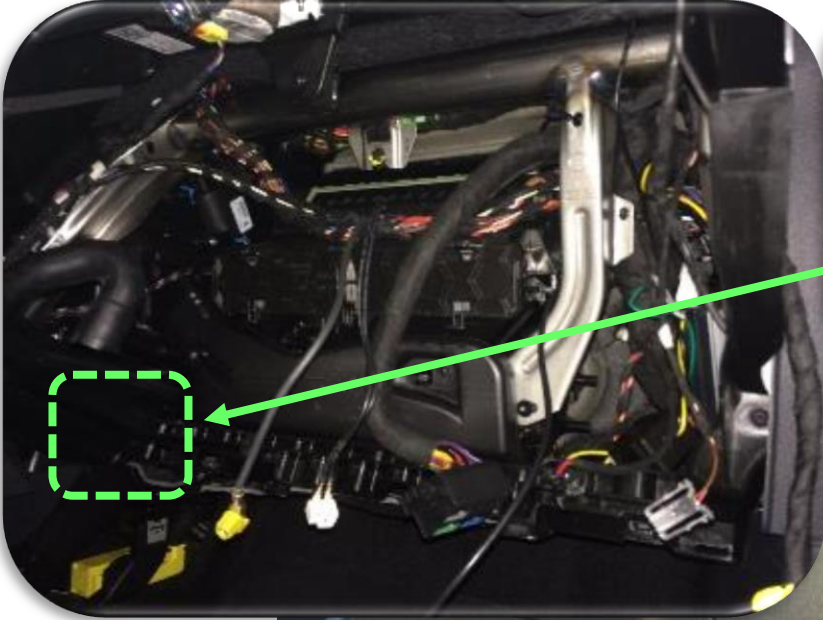

Déportez le connecteur FAKRA .

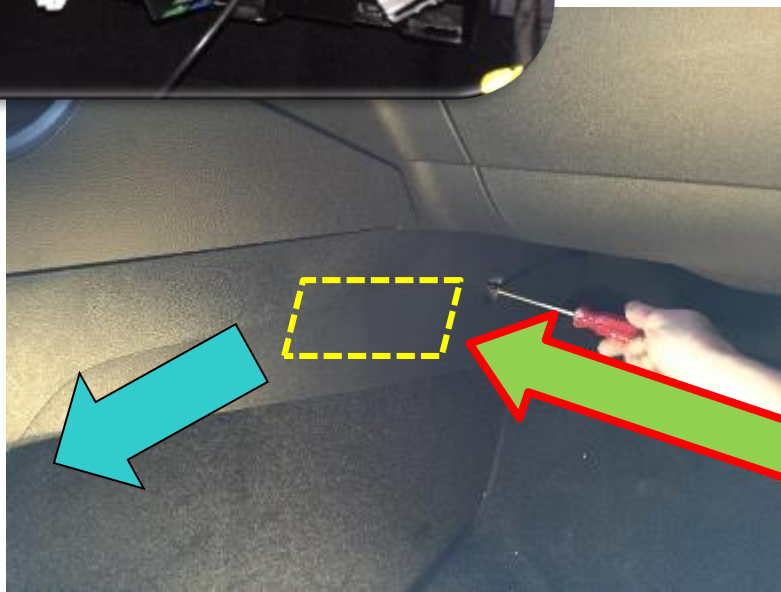

Extraire le flanc latéral de la console centrale.



Connexions des fils et de l'interface

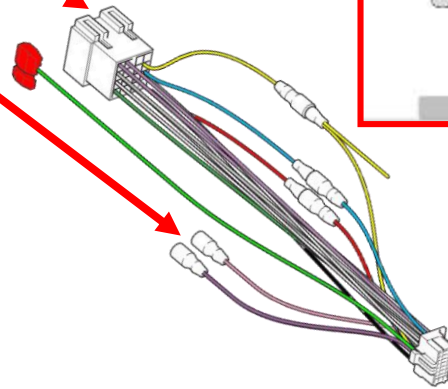
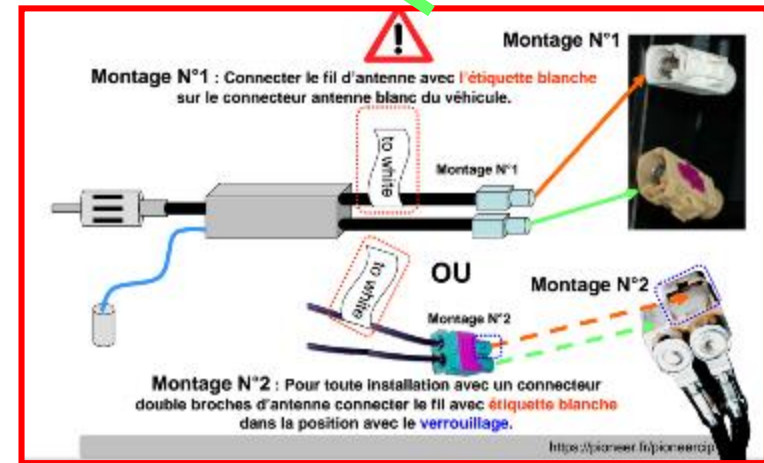
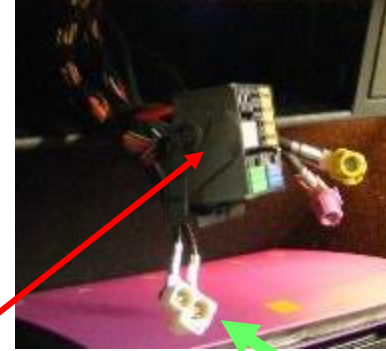

Connexions des fils et de l'interface

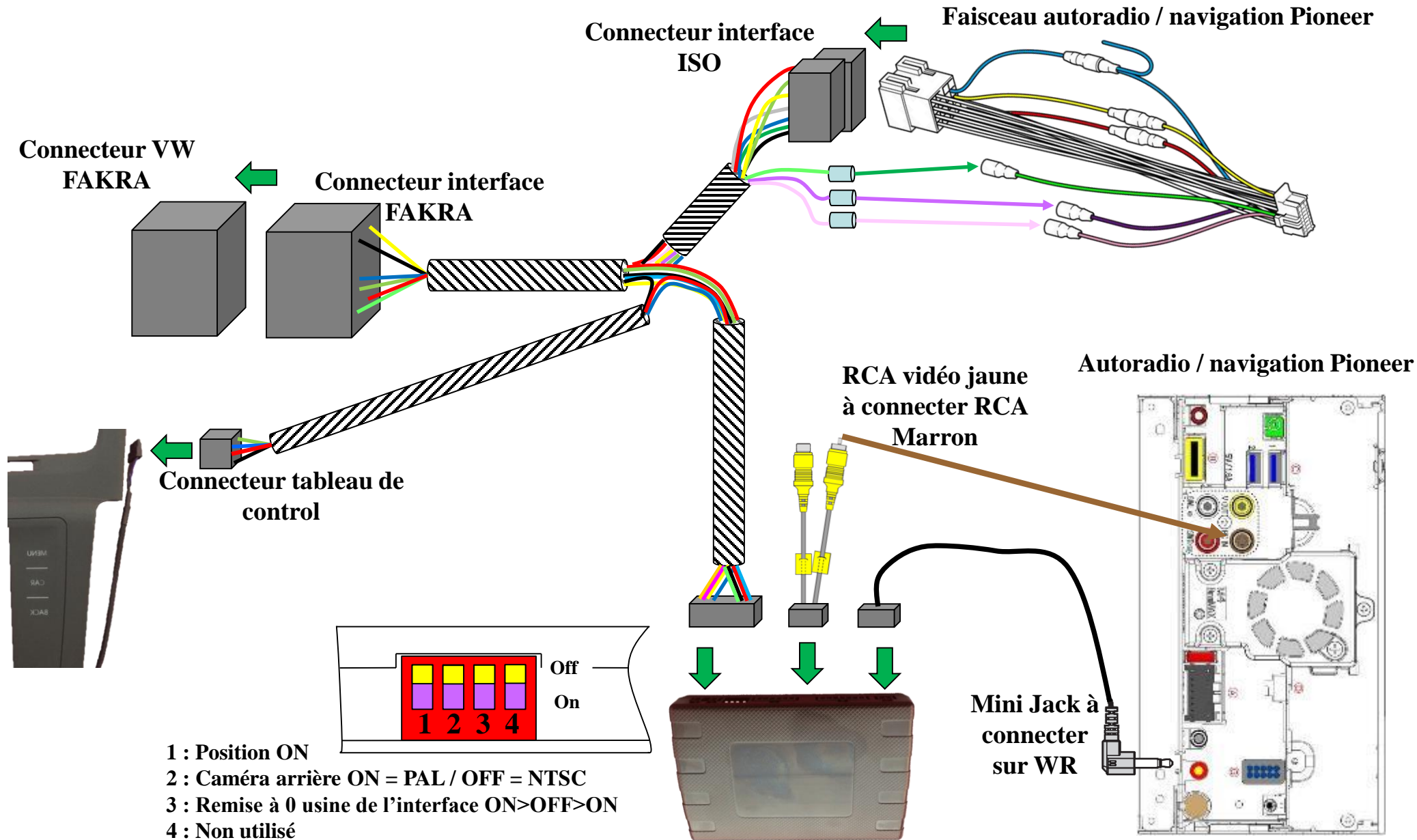

Préparation pour l'intégration du système.

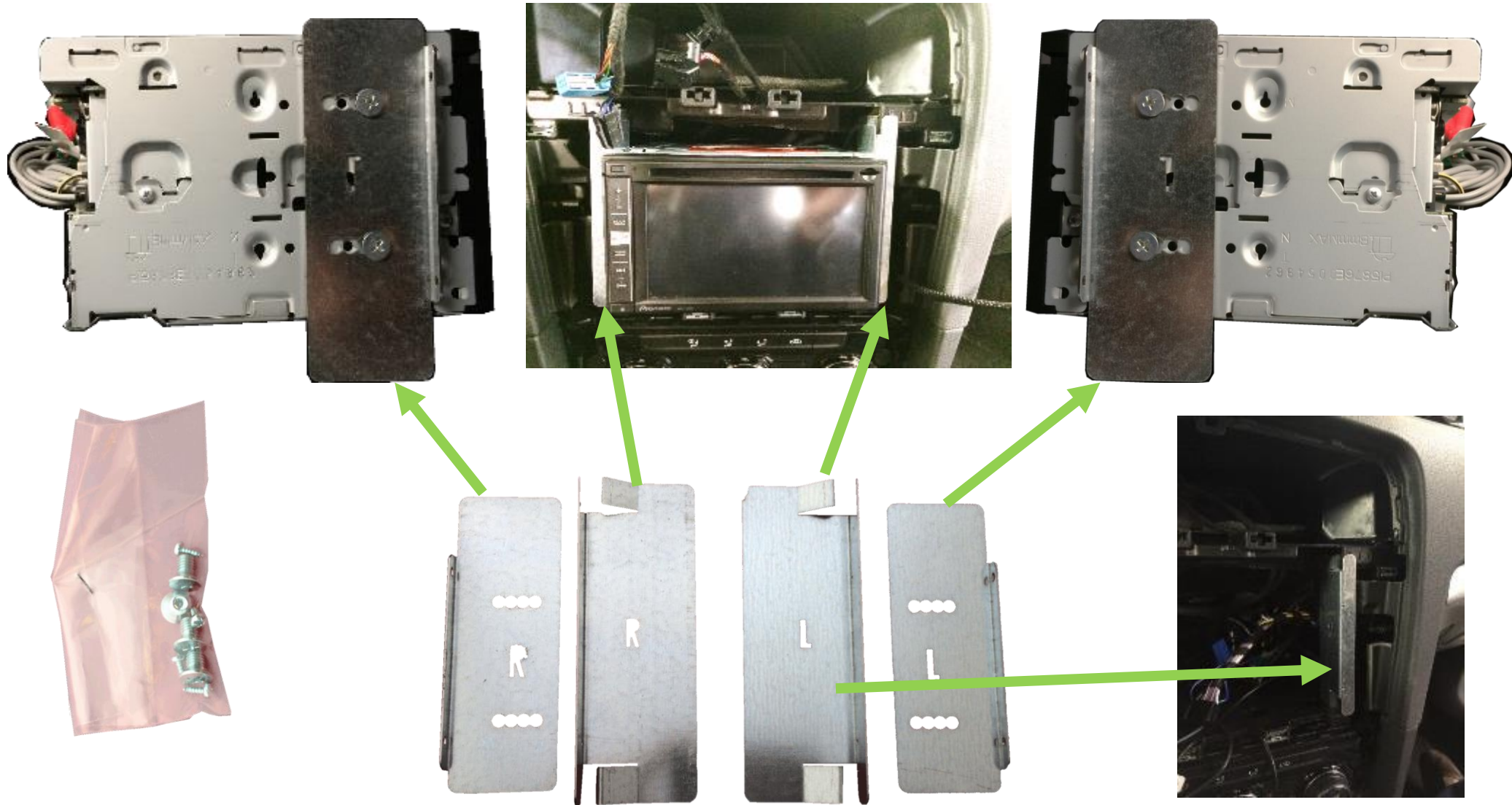

Préparation au remontage des enjoliveurs.

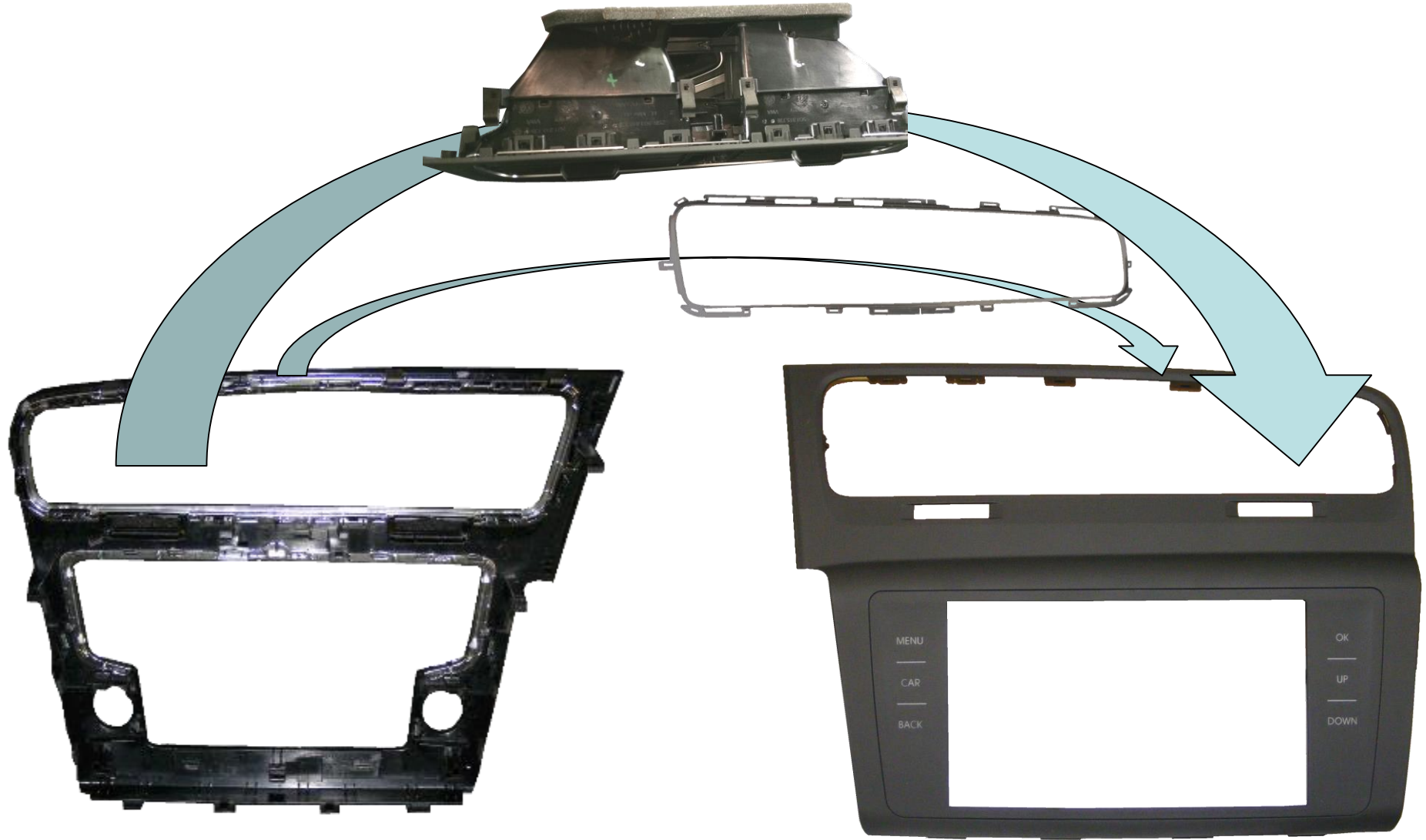

Démontez les deux bouches d'air puis le contour argenté pour les remonter sur le nouveau kit de montage.

Configuration de l'entrée vidéo pour le réglage de l'interface.

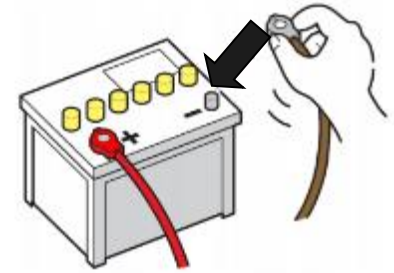

Rebrancher le câble négatif de la batterie

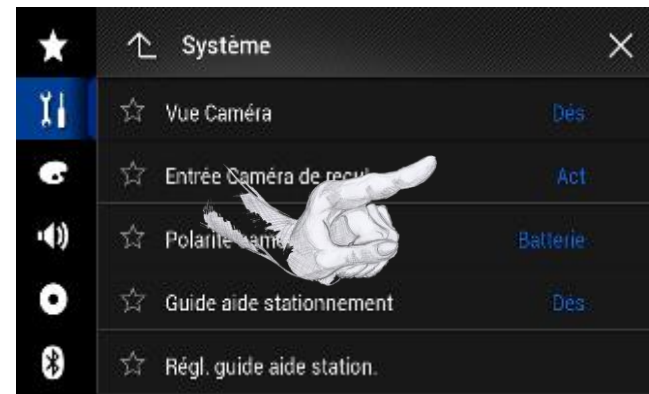
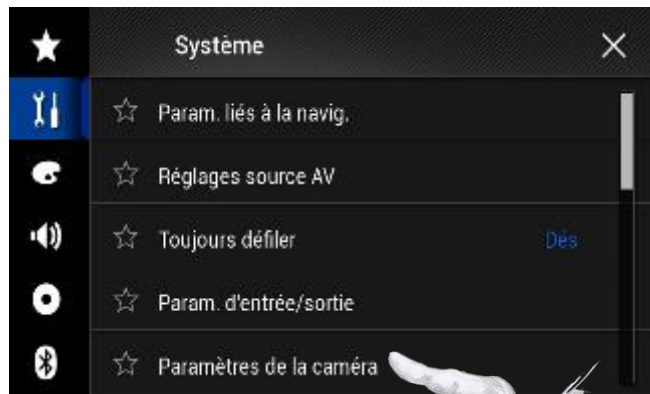
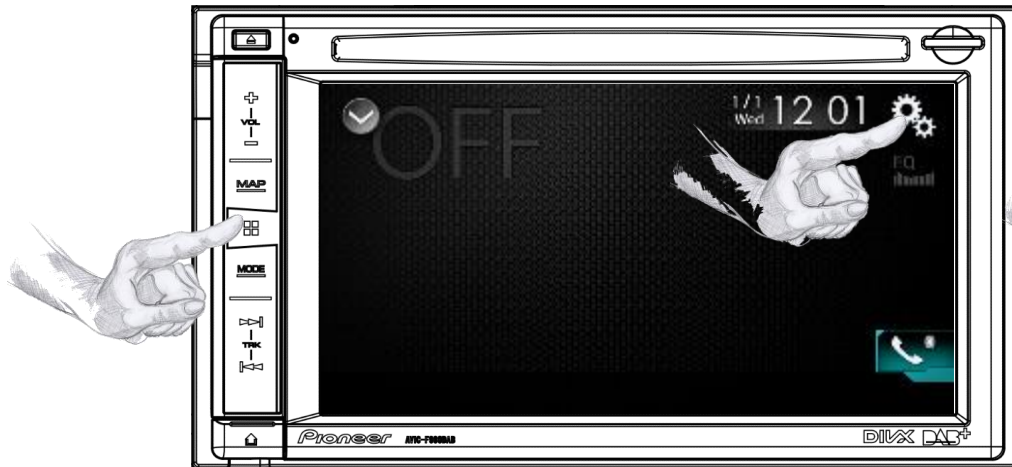

Inversez les commandes du clavier.

Dans certains cas, les commandes UP / DOWN / OK sont inversées, pour rétablir le bon ordre, appuyez sur la touche MENU plus de 6 secondes



Réglages initiaux de l'interface CA-R-VAG.001.

1

MENU

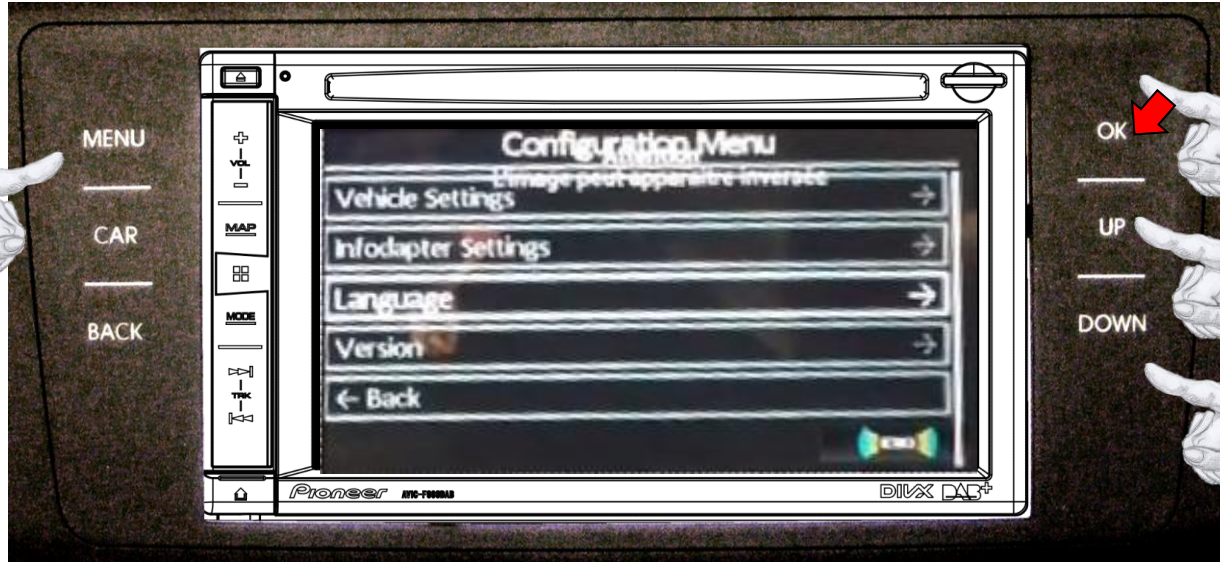

3

CONFIRMEZ (OK)



2

SELECTIONNEZ LANGUAGE

CONFIRMEZ (OK)

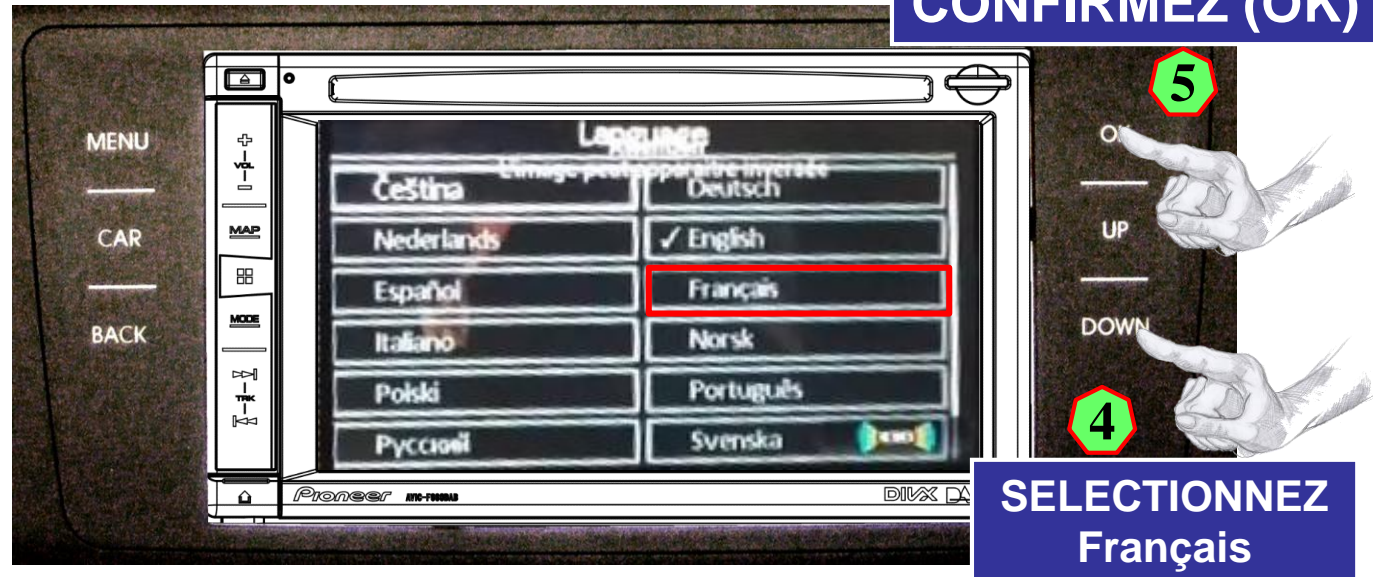

5

4

SELECTIONNEZ Français

Réglages initiaux de l'interface CA-R-VAG.001.

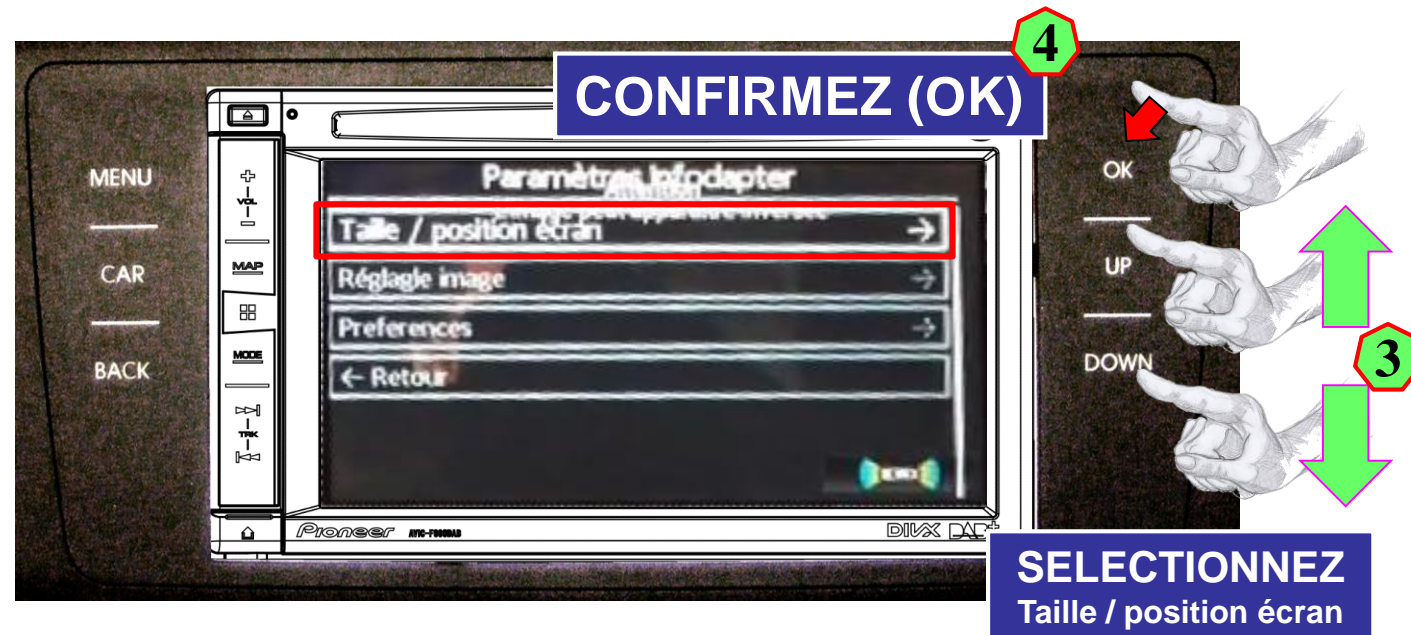
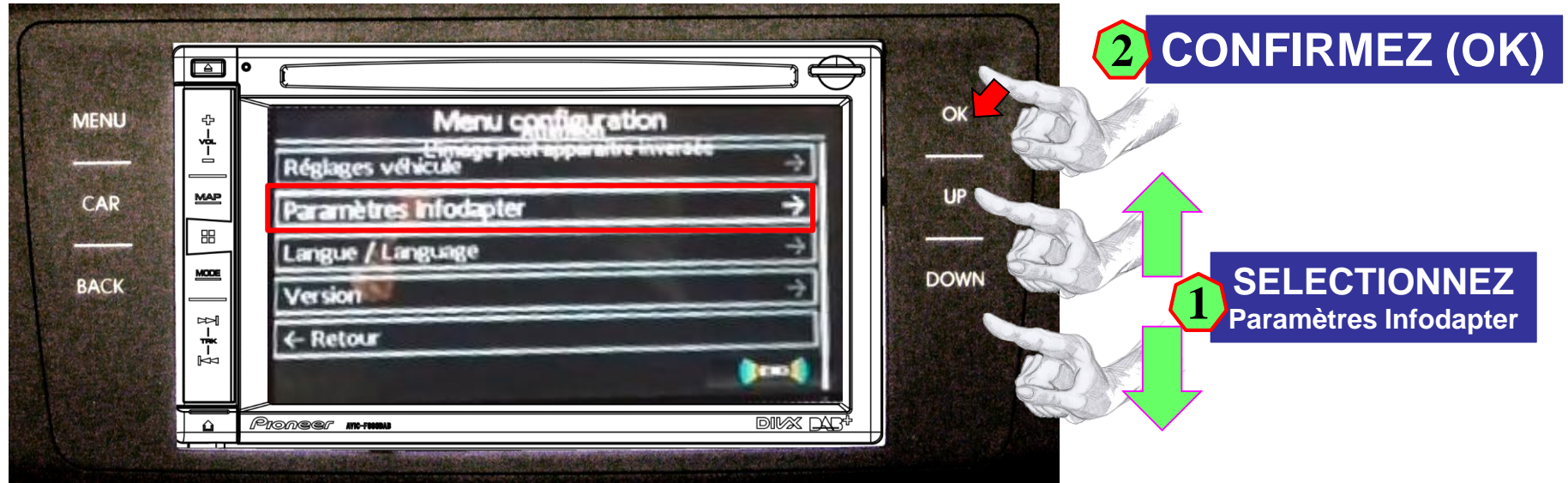

Réglages initiaux de l'interface CA-R-VAG.001.

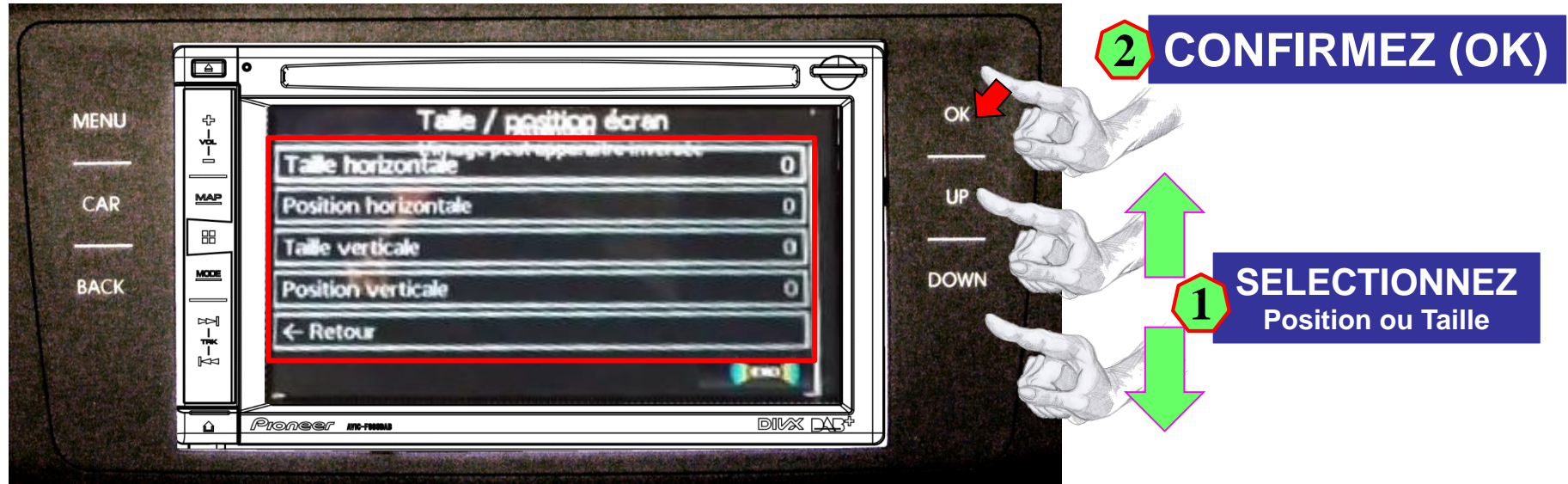

Positionnez la hauteur de l'écran sous le texte (Attention l'image peut apparaître inversée) à l'aide du menu Taille / position écran

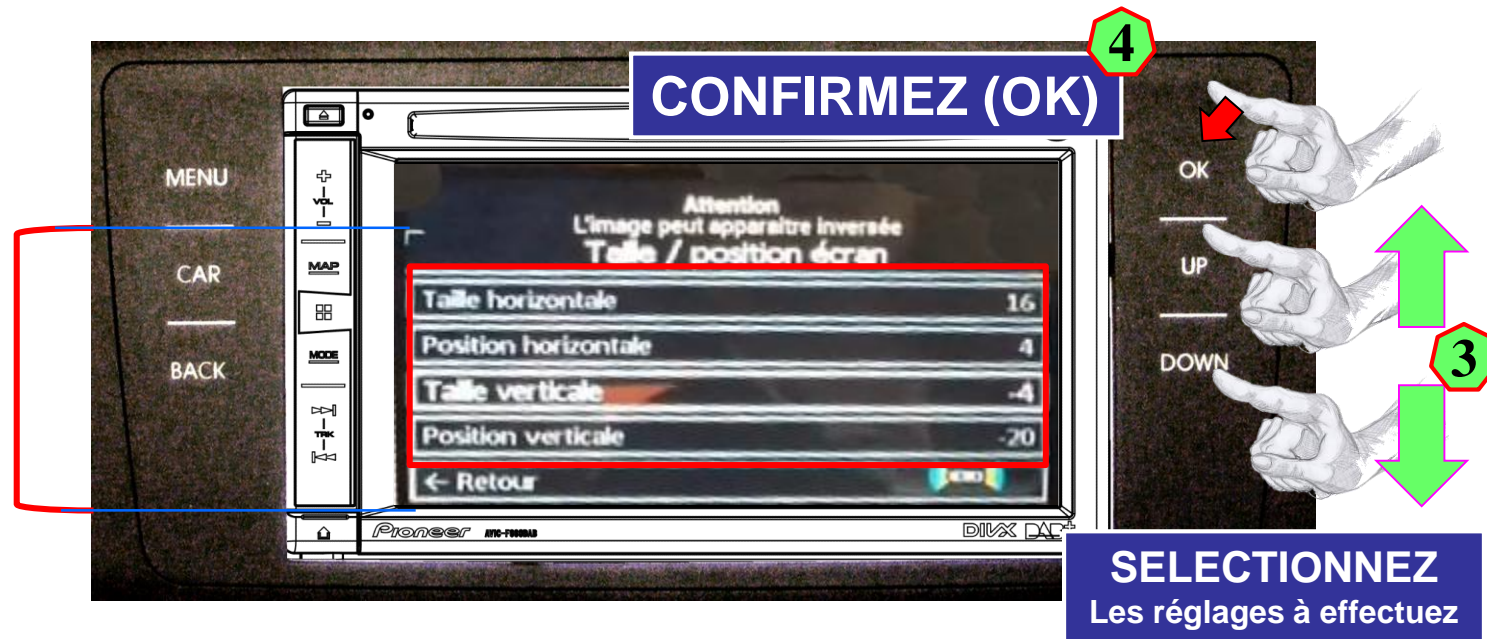

Réglages initiaux de l'interface CA-R-VAG.001.

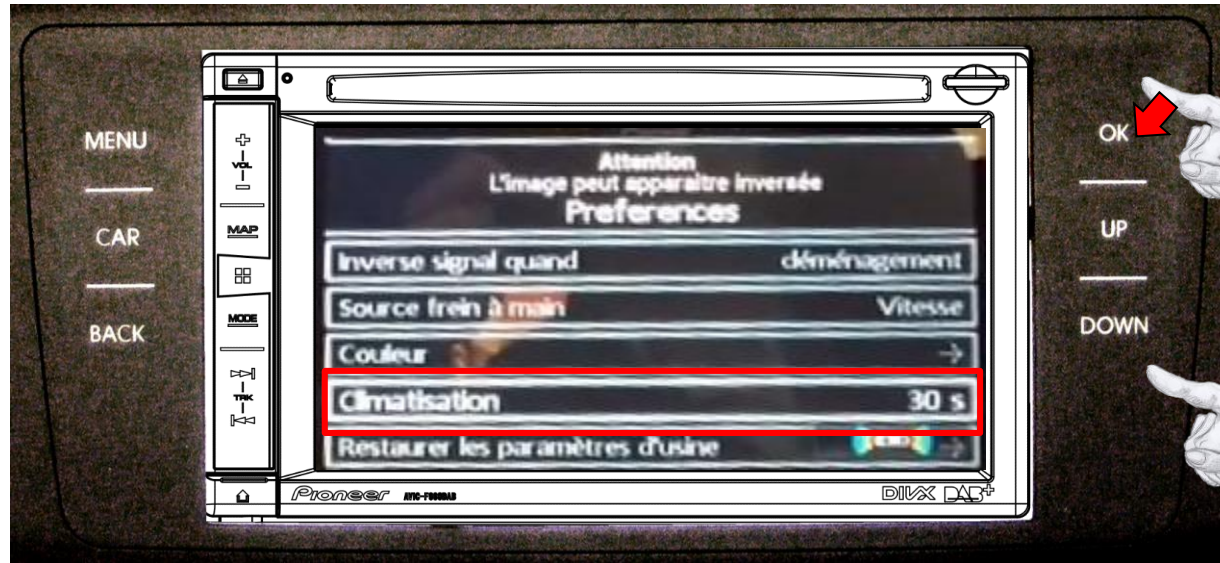

2 CONFIRMEZ (OK)

**1 SELECTIONNEZ
Climatisation**

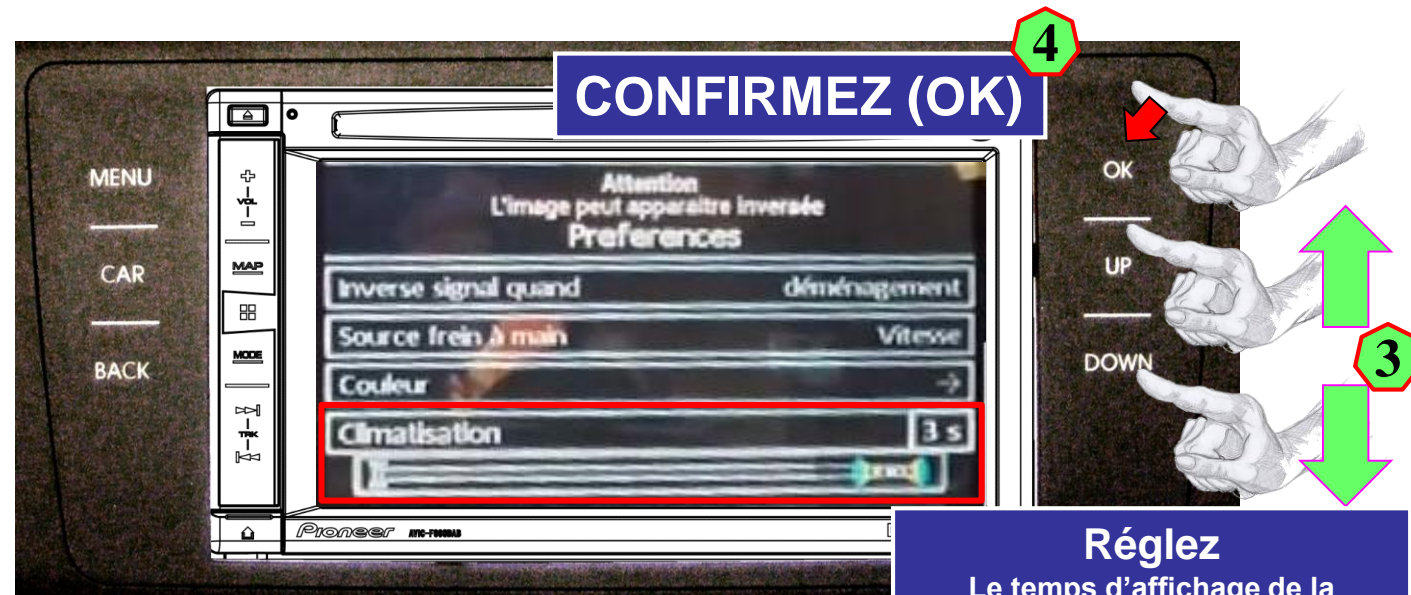

4 CONFIRMEZ (OK)

Réglez
Le temps d'affichage de la climatisation (3 à 6 secondes)