



INSTALLATION INSTRUCTIONS FOR PART 95-6513B

Dodge Durango 2011-2013 Jeep Grand Cherokee 2011-2013 95-6513B

KIT FEATURES

- Double DIN radio provision
- *Painted matte black to match factory*

KIT COMPONENTS

- A) Double DIN brackets

A

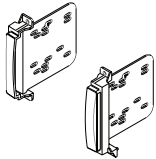

WIRING & ANTENNA CONNECTIONS (sold separately)

Wiring Harness: • CHT0-03 • XSVI-6522

Antenna Adapter: • 40-EU10

TOOLS REQUIRED

- Panel removal tool • Phillips screwdriver • Socket wrench • Cutting tool or file



Table of Contents

Dash Disassembly

- Dodge Durango 2011-2013 2
- Jeep Grand Cherokee 2011-2013 2

Kit Preparation 3

Kit Assembly

- Double DIN radio provision 3

CAUTION: *Metra recommends disconnecting the negative battery terminal before beginning any installation. All accessories, switches, and especially air bag indicator lights must be plugged in before reconnecting the battery or cycling the ignition.*

NOTE: *Refer to the instructions included with the aftermarket radio.*

REV. 4/30/2015 INST95-6513B

Dash Disassembly

Dodge Durango 2011-2013

1. Unclip and remove the panel around the radio including the climate controls. (Figure A)
2. Remove (4) 7mm screws securing the radio and remove. (Figure B)
3. Remove (3) 7mm screws securing the radio bracket to the sub dash. (Figure C)

Continue to kit preparation

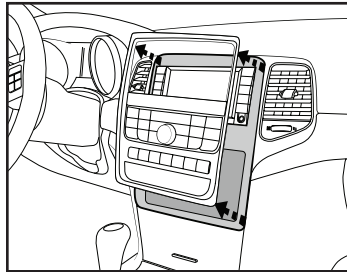

(Figure A)

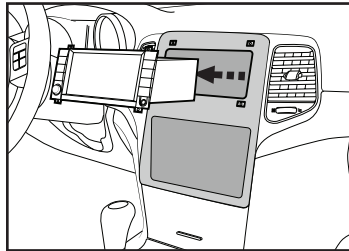

(Figure B)

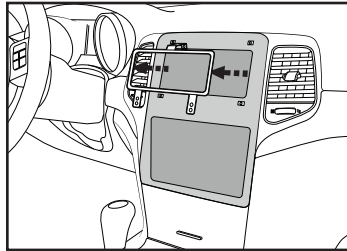

(Figure C)

Jeep Grand Cherokee 2011-2013

1. Unclip and remove the panel from around the radio including the vents and the climate controls. (Figure A)
2. Remove (4) 7mm screws securing the radio to the dash to remove. (Figure B)
3. Remove (3) 7mm screws securing the radio bracket to the sub dash. (Figure C)

Continue to kit preparation

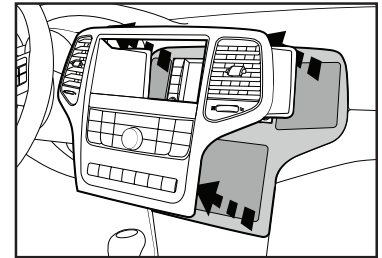

(Figure A)

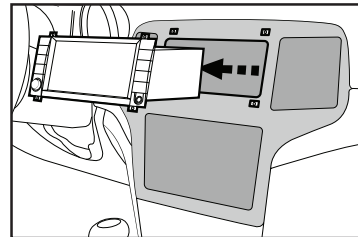

(Figure B)

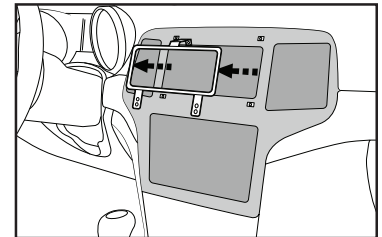

(Figure C)

Kit Preparation

1. Modification to the sub dash is necessary for the aftermarket double DIN radio to fit. You will need to trim the top and bottom of the sub dash cavity.

Continue to kit assembly

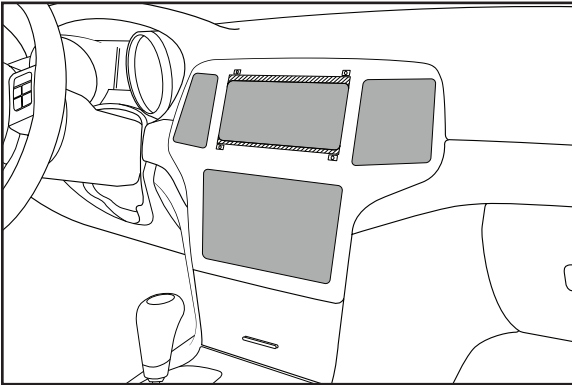

(Figure A)

Kit Assembly

Double DIN radio provision

1. Attach the double DIN brackets to the radio using the screws supplied with the radio. (Figure A)
2. Locate the factory wiring harness in the dash. Metra recommends using the proper mating adapter from
3. Reassemble the dash in reverse order of disassembly.

Metra or AXCESS. Re-connect the negative battery terminal and test the radio for proper operation.

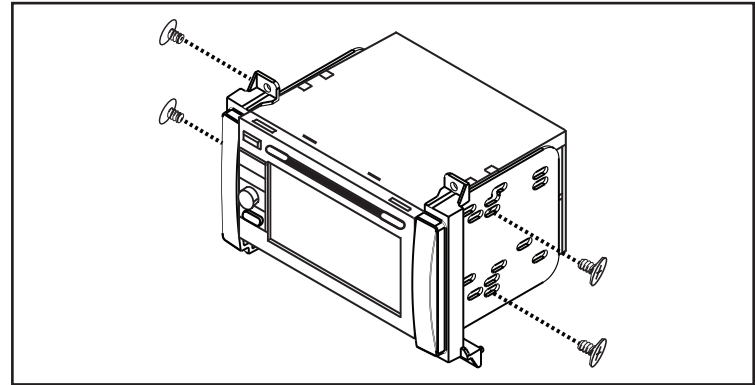

(Figure A)



INSTALLATION INSTRUCTIONS FOR PART 95-6513B



REV. 4/30/2015 INST95-6513B



KNOWLEDGE IS POWER

Enhance your installation and fabrication skills by enrolling in the most recognized and respected mobile electronics school in our industry. Log onto www.installerinstitute.com or call 800-354-6782 for more information and take steps toward a better tomorrow.



Metra recommends MECP certified technicians



INSTRUCCIONES DE INSTALACIÓN PARA LA PIEZA 95-6513B

Dodge Durango 2011-2013 Jeep Grand Cherokee 2011-2013 95-6513B

CARACTERÍSTICAS DEL KIT

- Provisión de radio doble DIN
- *Pintura negro mate para igualar el acabado de fábrica*

COMPONENTES DEL KIT

- A) Soportes doble DIN

A

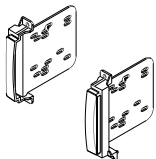

CABLEADO Y CONEXIONES DE ANTENA (se venden por separado)

Arnés de cableado: • CHT0-03 • XSVI-6522

Adaptador de antena: • 40-EU10

HERRAMIENTAS REQUERIDAS

- Herramienta de remoción de panel • Destornillador Phillips • Llave de tubo • Herramienta de corte o lima



Indice

Desmontaje del tablero

- Dodge Durango 2011-2013 2
- Jeep Grand Cherokee 2011-2013 2

Preparación del kit 3

Ensamble del kit

- Provisión de radio doble DIN..... 3

PRECAUCIÓN: Metra recomienda desconectar el terminal negativo de la batería antes de comenzar cualquier instalación. Todos los accesorios, interruptores y, especialmente, las luces indicadoras de airbag deben estar enchufados antes de volver a conectar la batería o comenzar el ciclo de ignición.

NOTA: Remítase a las instrucciones incluidas con el radio de postventa.

Desmontaje del tablero

Dodge Durango 2011-2013

1. Desenganche y quite el panel que rodea el radio, incluyendo los controles de clima. (Figura A)
2. Retire los (4) tornillos de 7mm que sujetan la radio y retire. (Figura B)
3. Retire (3) tornillos de 7 mm que fijan el soporte de radio a la sub tablero. (Figura C)

Continuará la preparación del kit

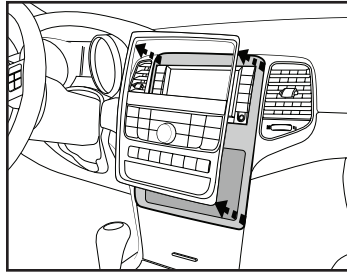

(Figura A)

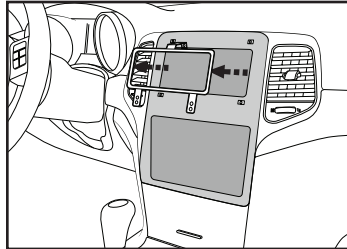

(Figura C)

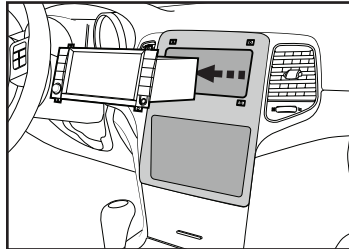

(Figura B)

Jeep Grand Cherokee 2011-2013

1. Desenganche y quite el panel que rodea el radio, incluyendo las rejillas y los controles de clima. (Figura A)
2. Retire los (4) tornillos de 7mm que sujetan el radio al tablero y retire. (Figura B)
3. Quite los (3) tornillos de 7 mm que sujetan el soporte del radio al sub tablero. (Figura C)

Continuará la preparación del kit

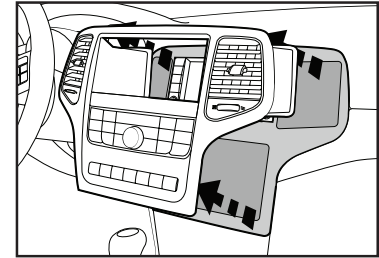

(Figura A)

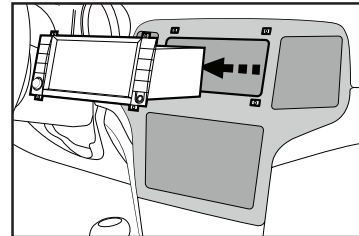

(Figura B)

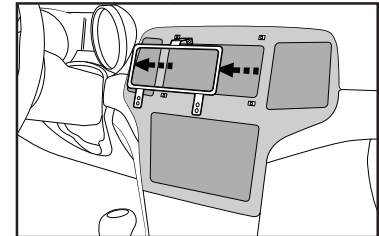

(Figura C)

Preparación del kit

1. Es necesario modificar el sub tablero para que quepa el radio doble DIN. Tendrá que recortar la parte superior e inferior de la cavidad del sub tablero.

Continuará al ensamble del kit

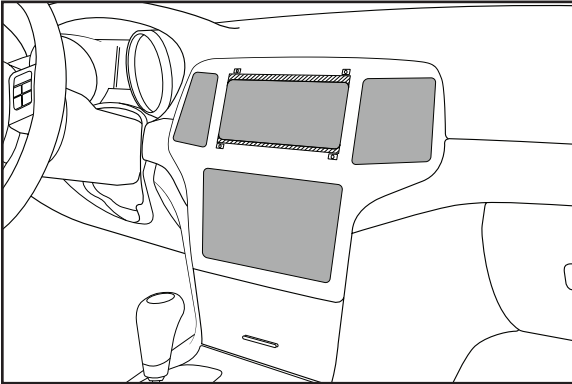

(Figura A)

Ensamble del kit

Provisión de radio doble DIN

1. Coloque los soportes doble DIN en el radio de mercado secundario usando los tornillos que vienen con el radio. (Figura A)
2. Ubique el arnés de cableado de fábrica en el tablero. Metra recomienda el uso de un adaptador adecuado de acoplamiento de Metra o de AXCESS. Vuelva a conectar la terminal negativa de la batería y pruebe la unidad para verificar que funcione correctamente.
3. Vuelva a armar el tablero al revés de como lo desarmó.

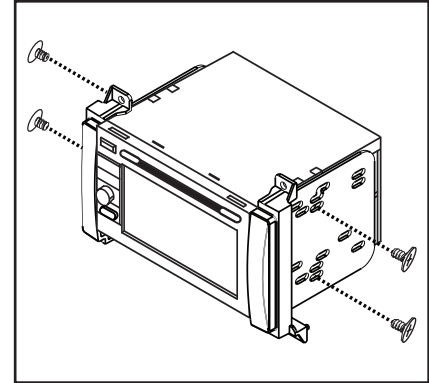

(Figura A)



INSTRUCCIONES DE INSTALACIÓN PARA LA PIEZA 95-6513B



REV. 4/30/2015 INST95-6513B



EL CONOCIMIENTO ES PODER
Mejore sus habilidades de instalación y fabricación inscribiéndose en la escuela de dispositivos electrónicos móviles más reconocida y respetada de nuestra industria. Regístrese en www.installerinstitute.com o llame al 800-354-6782 para obtener más información y avance hacia un futuro mejor.



Metra recomienda técnicos con certificación del Programa de Certificación en Electrónica Móvil (Mobile Electronics Certification Program, MECP).