

7. Clean sticker areas of fascia plate

Attach replacement stickers for

PASSENGER (right)

PASSENGER AIRBAG OFF (left)

on double DIN fascia plate (see arrows)

8. Attach metal mounting brackets to double DIN Navigation

Connect all required circuit points

9. Connect all required circuit points

Place navigation and fix it (see arrows)

10. Connect hazard light switch connector an other required connections

Place fascia plate until it snaps in

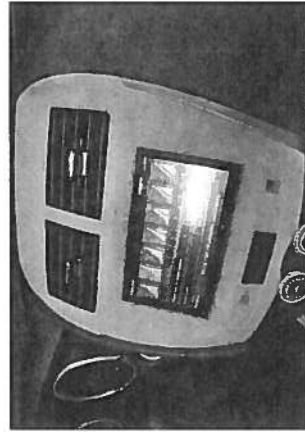
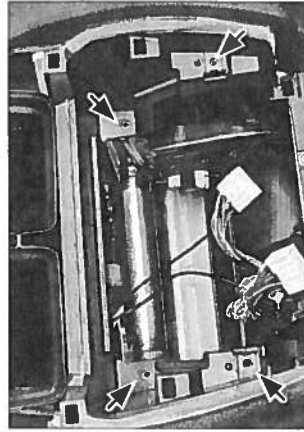
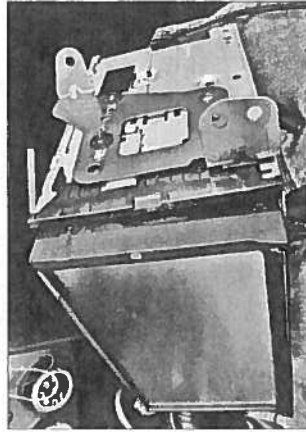
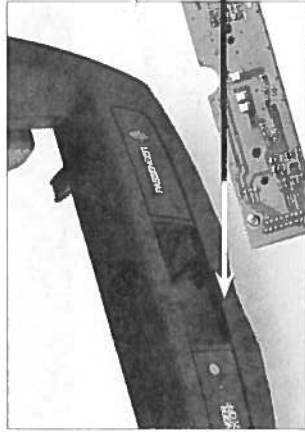

Installation Manual Double DIN Kit

make / type	colour	part-no...
• Mitsubishi ASX 06/2010->	black	381200-11
• Mitsubishi ASX 06/2010->	black	281200-11 (with pocket)
• Citroën C4 Aircross Type B 06/2012->	black-nacre (piano-optic)	381200-11-2
• Peugeot 4008 Type B 06/2012->		

Double DIN Kit contents

- (1) Facia Plate
 - (2) Mounting Bracket Right
 - (3) Mounting Bracket Left
 - (4) Replacement PCB
 - (5) Sticker
 - (6) Fixing Screws
 - (7) Pocket (1-DIN install)*
- *ONLY for 281200-11

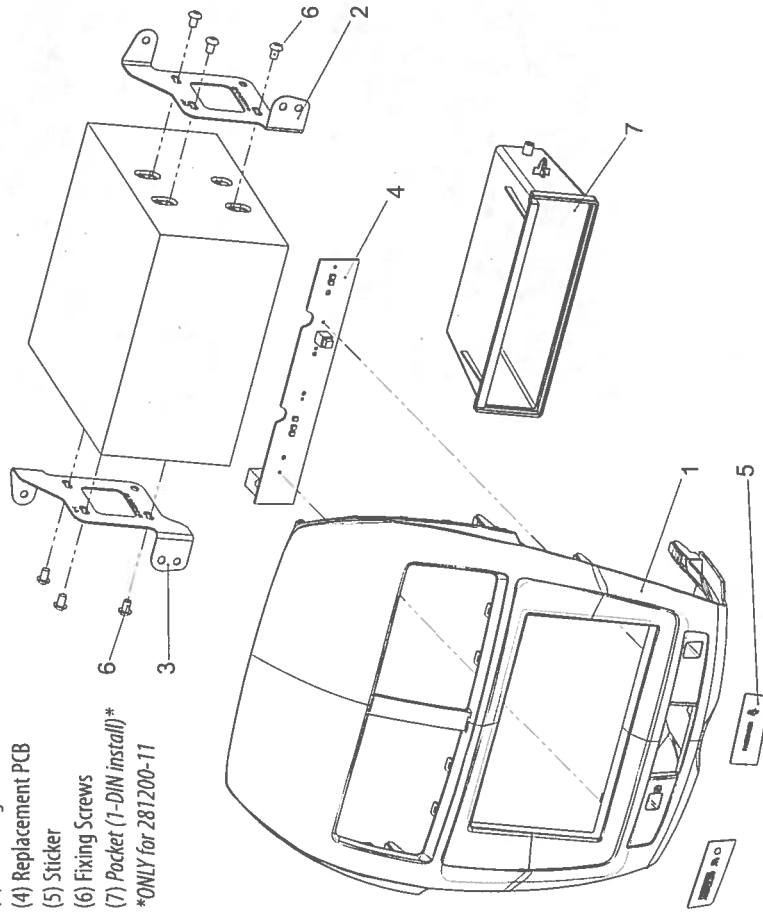

Installation Manual Double DIN Kit Mitsubishi ASX



1. Mitsubishi ASX with OEM-Radio
Unclip OEM center panel
Unplug cables carefully
Remove OEM center panel

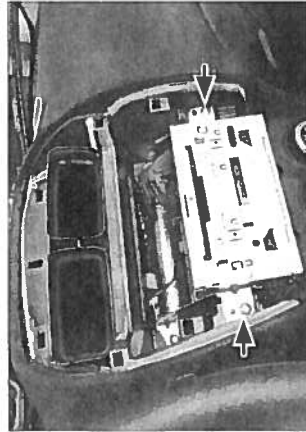

2. Remove OEM Radio/CD device

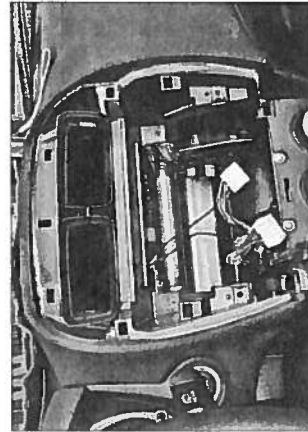

3. Dashboard with removed OEM Radio/CD device

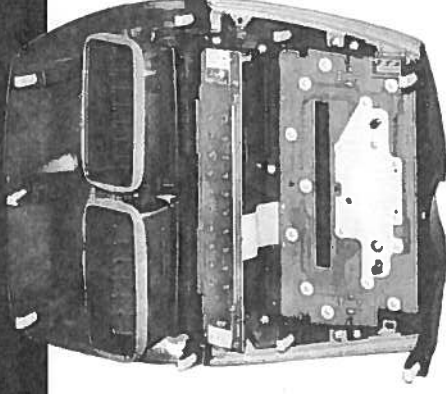

4. Dismount air vents left and right. Remove OEM circuit board (PCB).
Dismount hazard light switch
Dismount silver side panels
Dismount clips

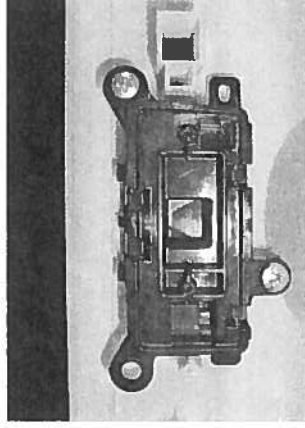

5. Mount hazard light switch to fascia plate

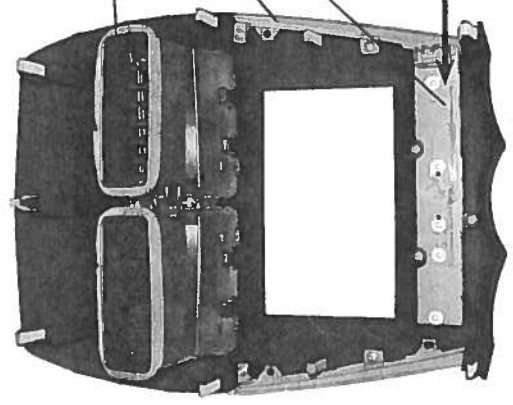

6. Mount
• OEM air vents
• OEM silver side panels
• replacement PCB to fascia plate



*All installation work must be performed by a qualified professional installer only.
The manufacturer / dealer is not liable for any kind of incidental or indirect damages.*