

Guide de montage d'un système de navigation et caméra dans une MITSUBISHI L200 -2013.

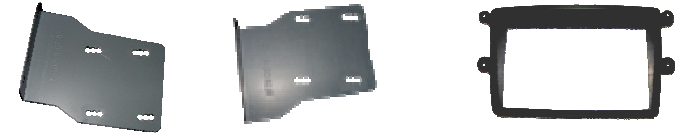

Pièces Pioneer

Kit 2 Din réf : CA-HM-MIT002



Interface électrique :
réf : CA-R-MIT.004 chez PIONEER

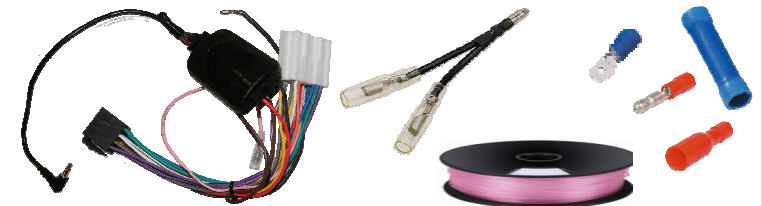

Caméra vue arrière :
Réf : ND-BC6



Casquette chez Mitsubishi
réf : MN179267XA

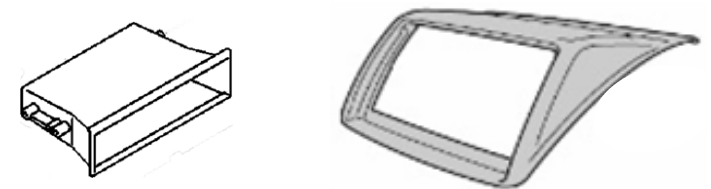

Dépose de l'autoradio d'origine

Mesures de sécurité



Avant toute intervention sur le véhicule!!!

- Contrôler la tension de courant du véhicule **+/- 12 V**.
- Le pôle **négatif** de la batterie à la **carrosserie**.
- Afin d'éviter tout risque de court-circuit et de réinitialisation du système électrique du véhicule, **débrancher le câble** de la borne négative de la batterie avant de commencer la pose.

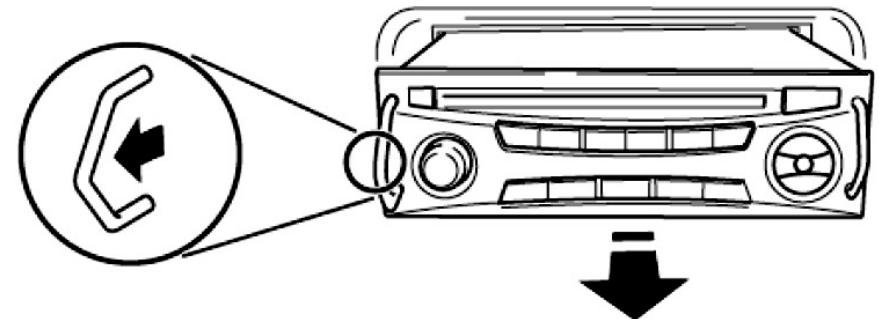
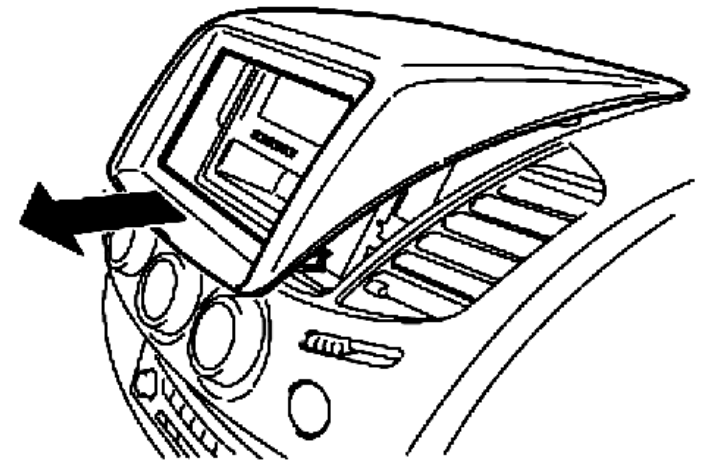
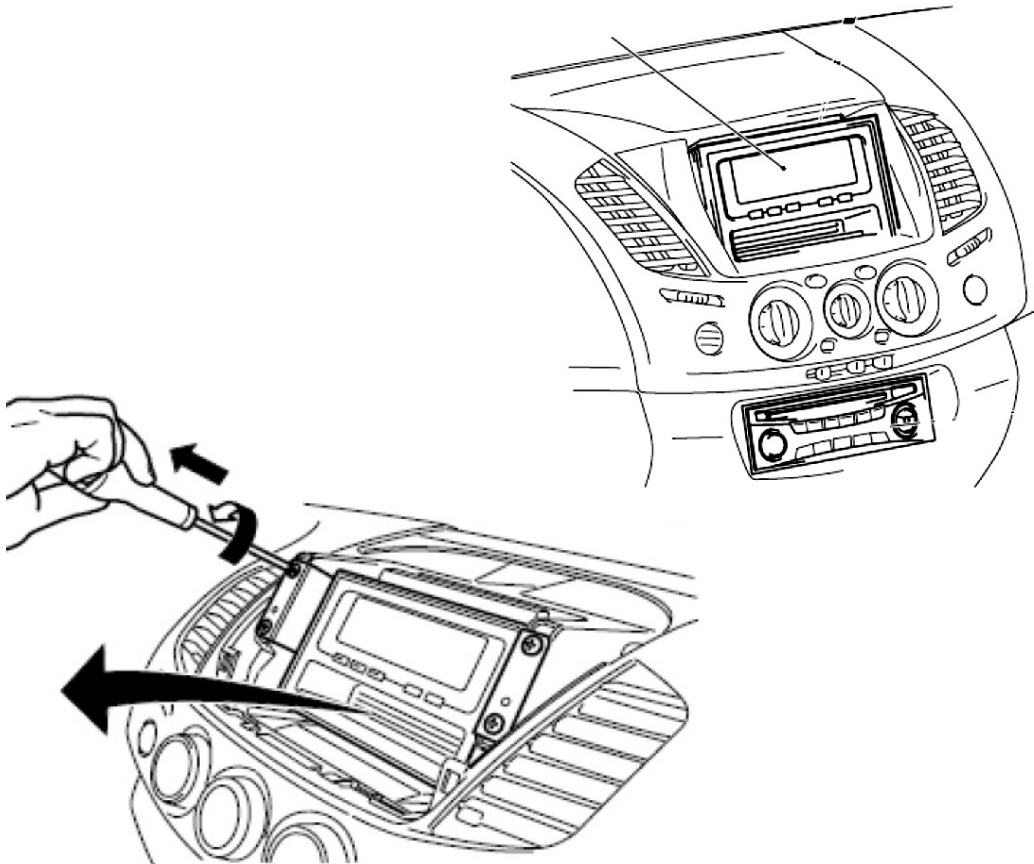
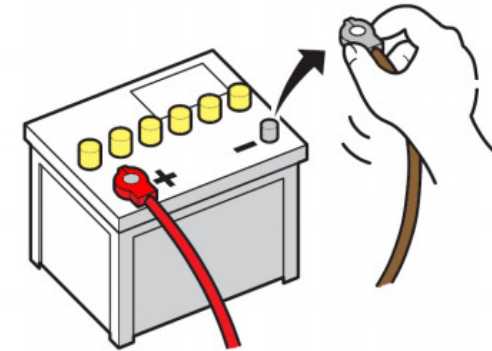

Dépose du tableau de contrôle

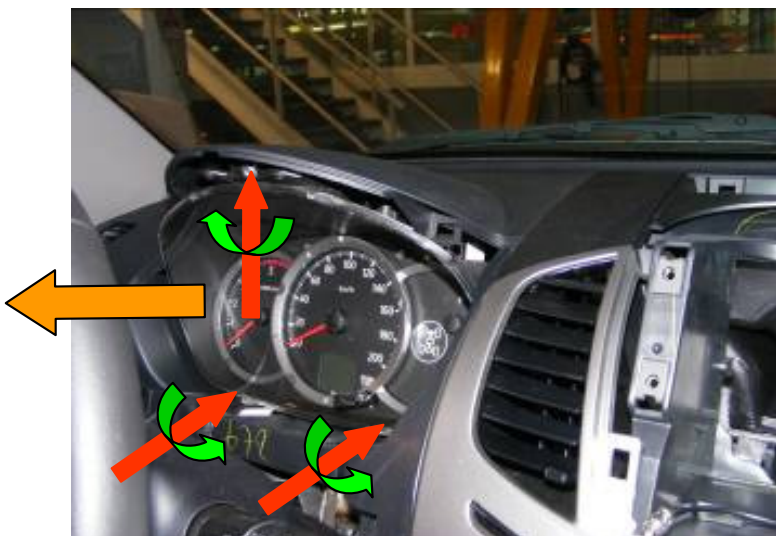

*Passage du câble
d'information
marche arrière*

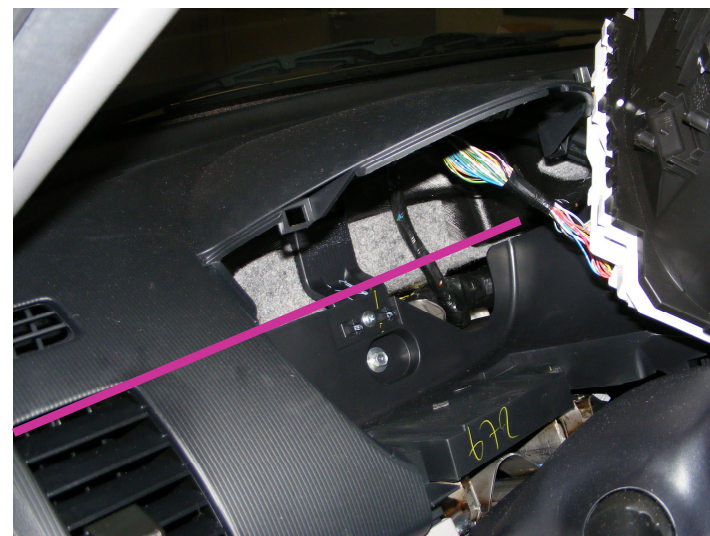

Installation du micro.

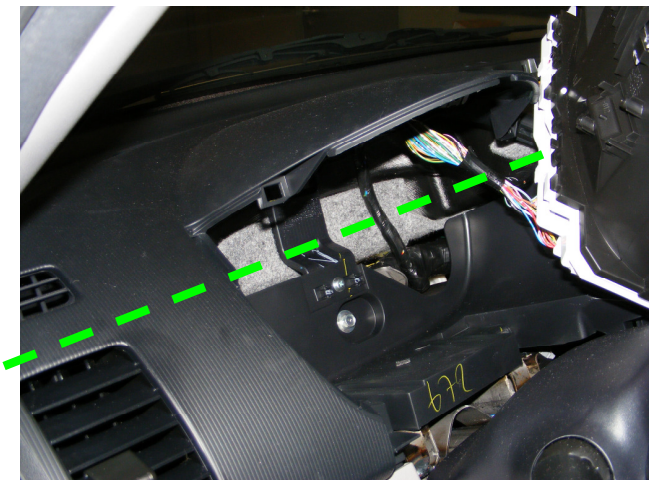
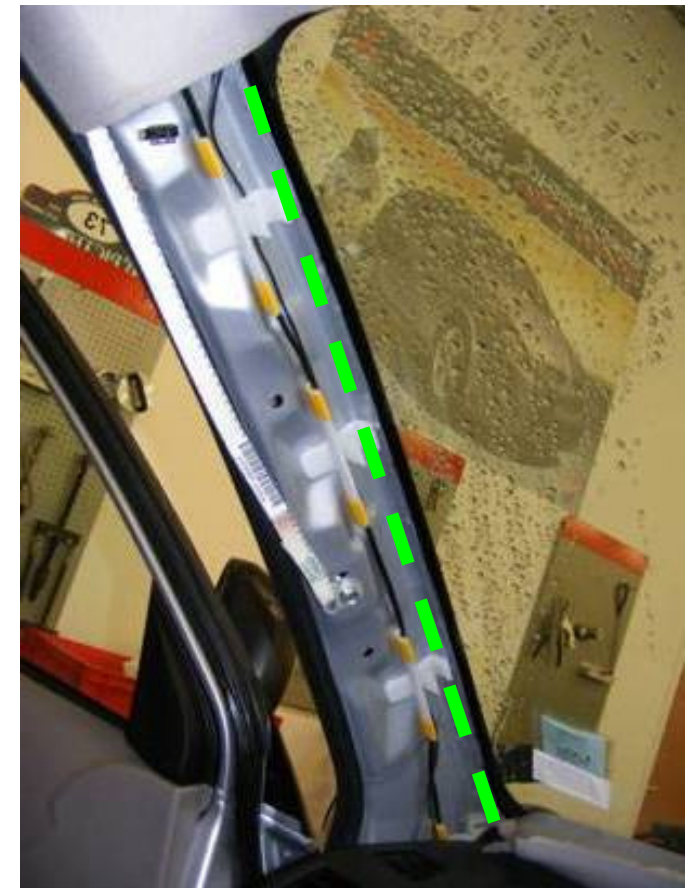

*Passage du câble
du micro*

Connexion du fil marche arrière

Signal marche arrière

fil Rouge/Vert du faisceau Mitsubishi avec le fil Rose de l'autoradio Pioneer REVERSE

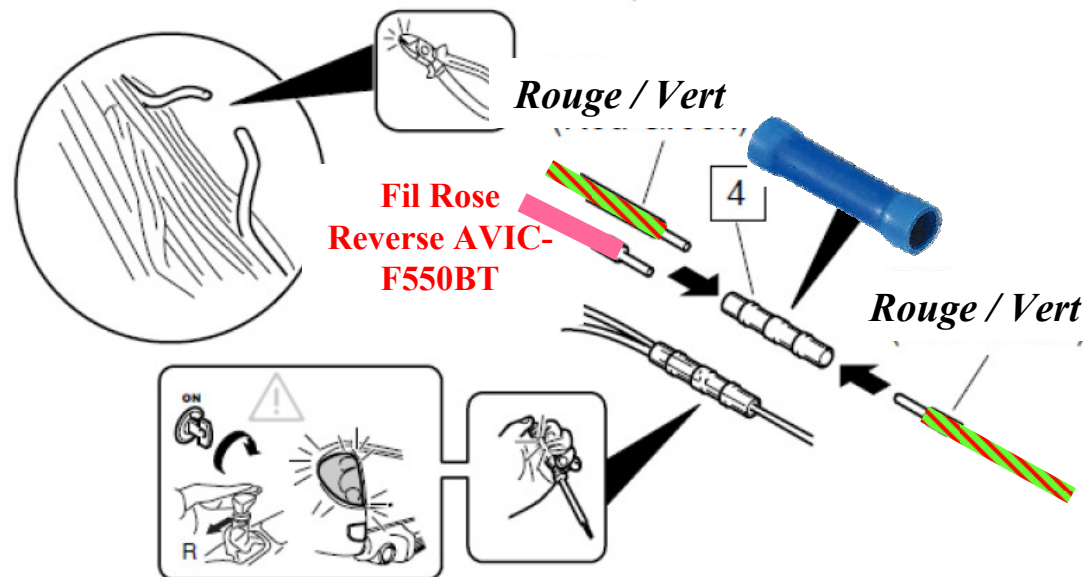
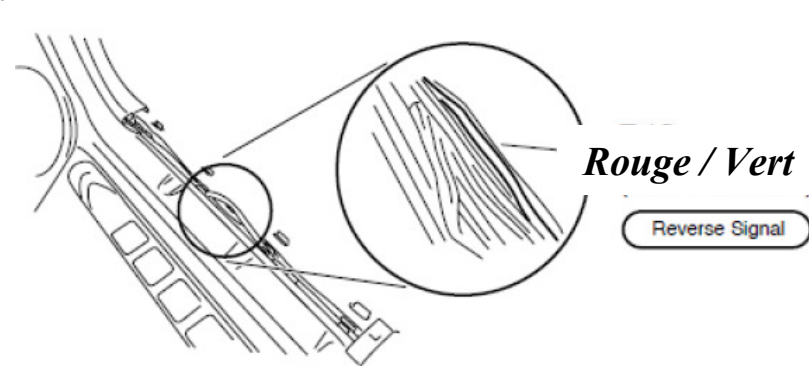
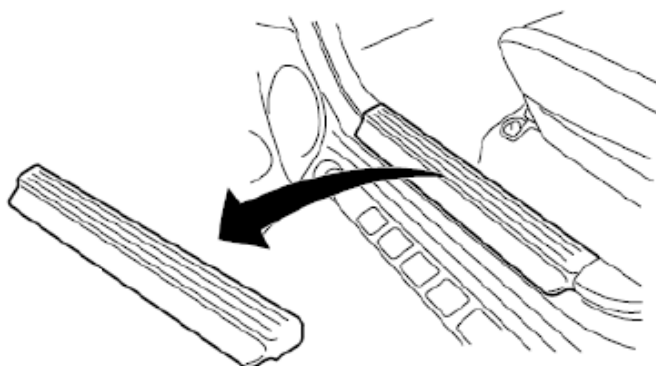
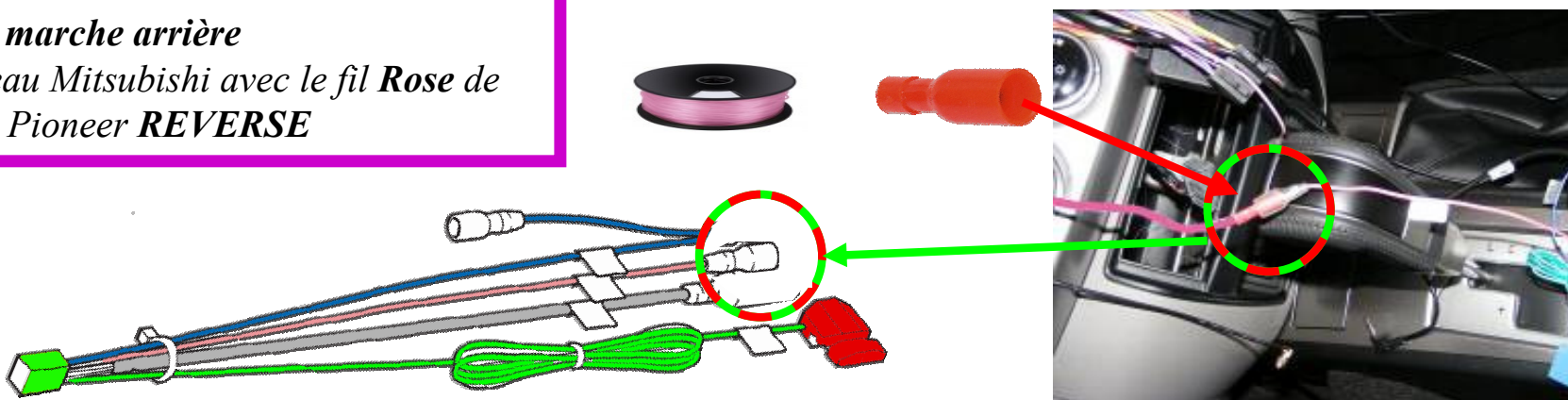
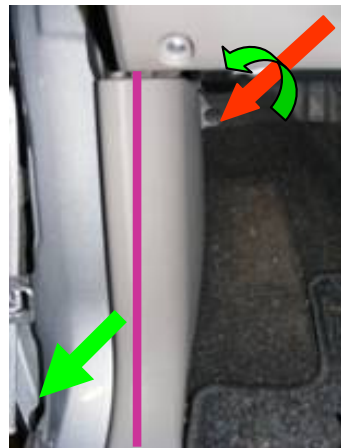
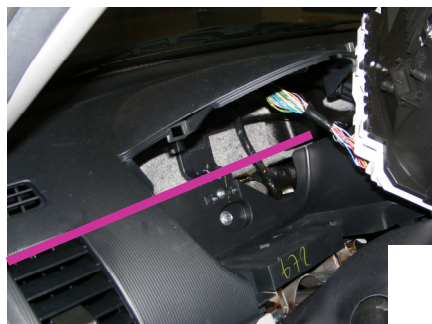

Passage du câble d'information marche arrière

Connexion du fil sécurité frein à main

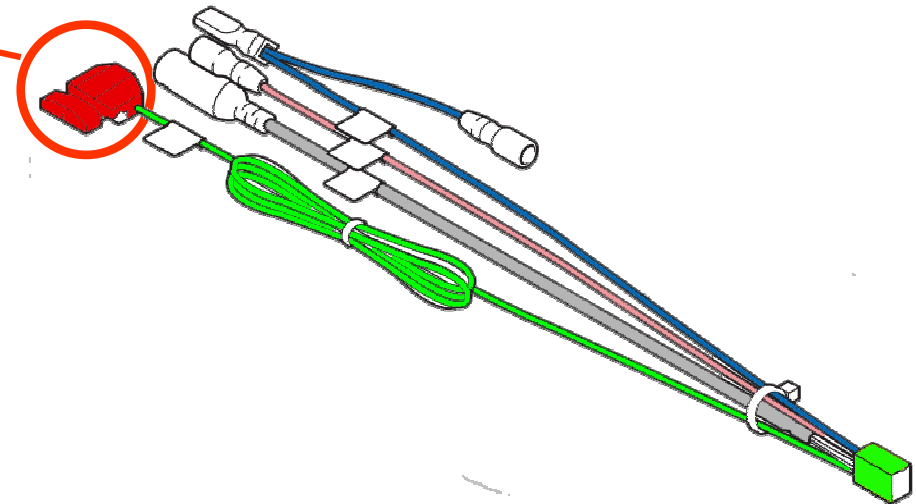
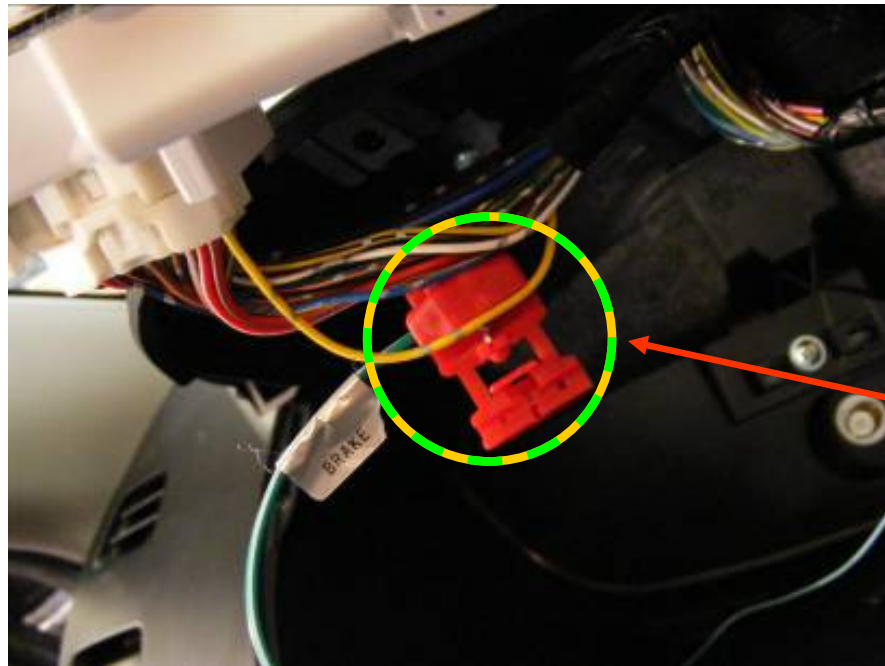

Signal sécurité
*le fil Vert Pioneer **PARKING BRAKE***
sur le fil Jaune du compteur

Installation de l'antenne GPS.



Poser l'antenne GPS avec le double faces.

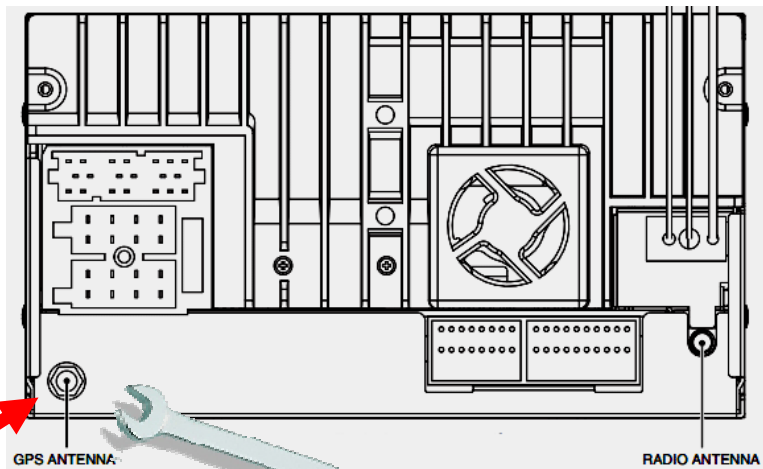

Double faces avec antenne GPS

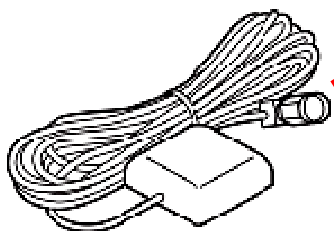

Serrer légèrement le connecteur de l'antenne GPS

Connexions des fils et de l'interface

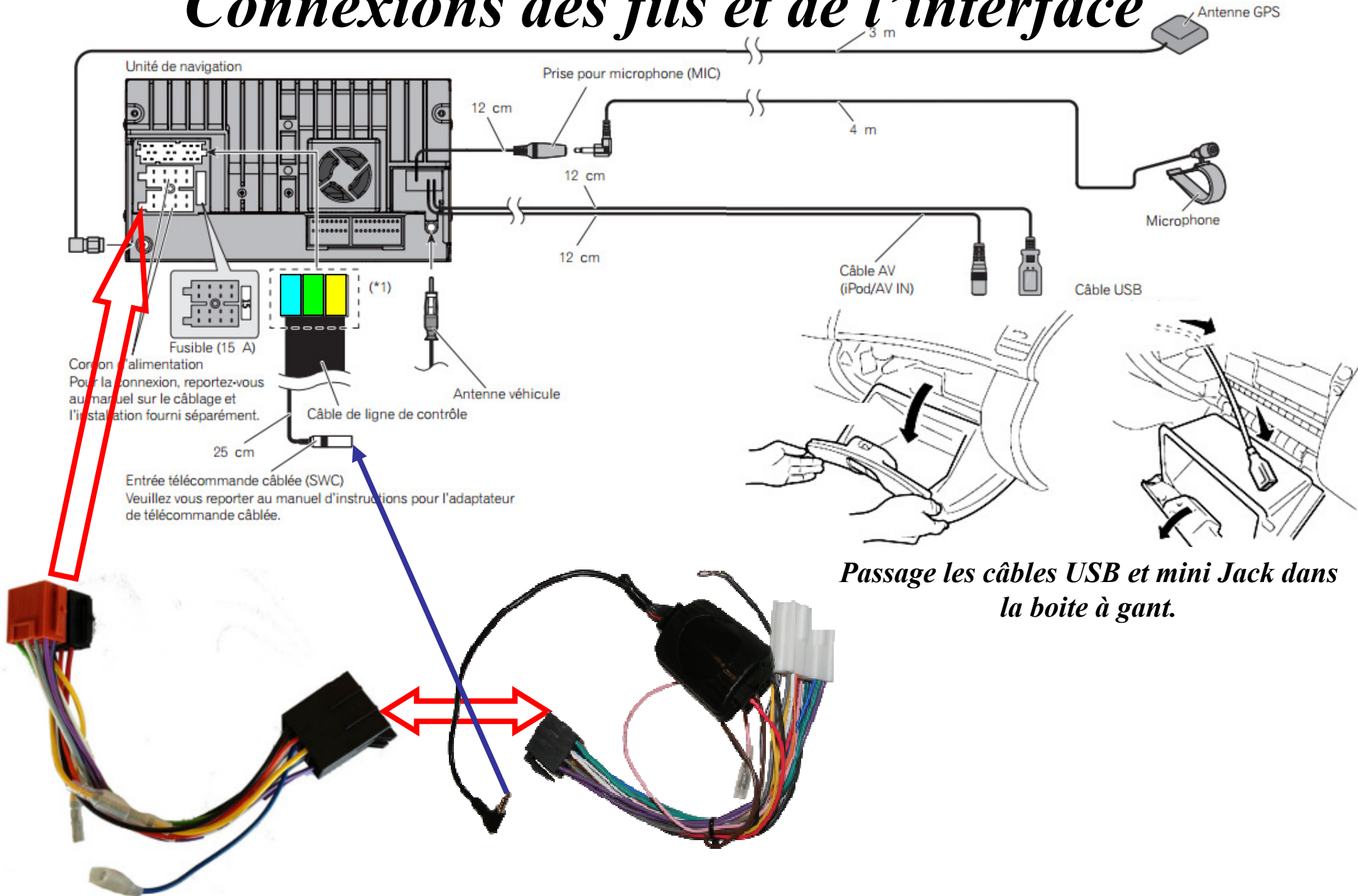

Passage les câbles USB et mini Jack dans la boîte à gant.

Raccordement du fil d'amplification antenne

Unité de navigation

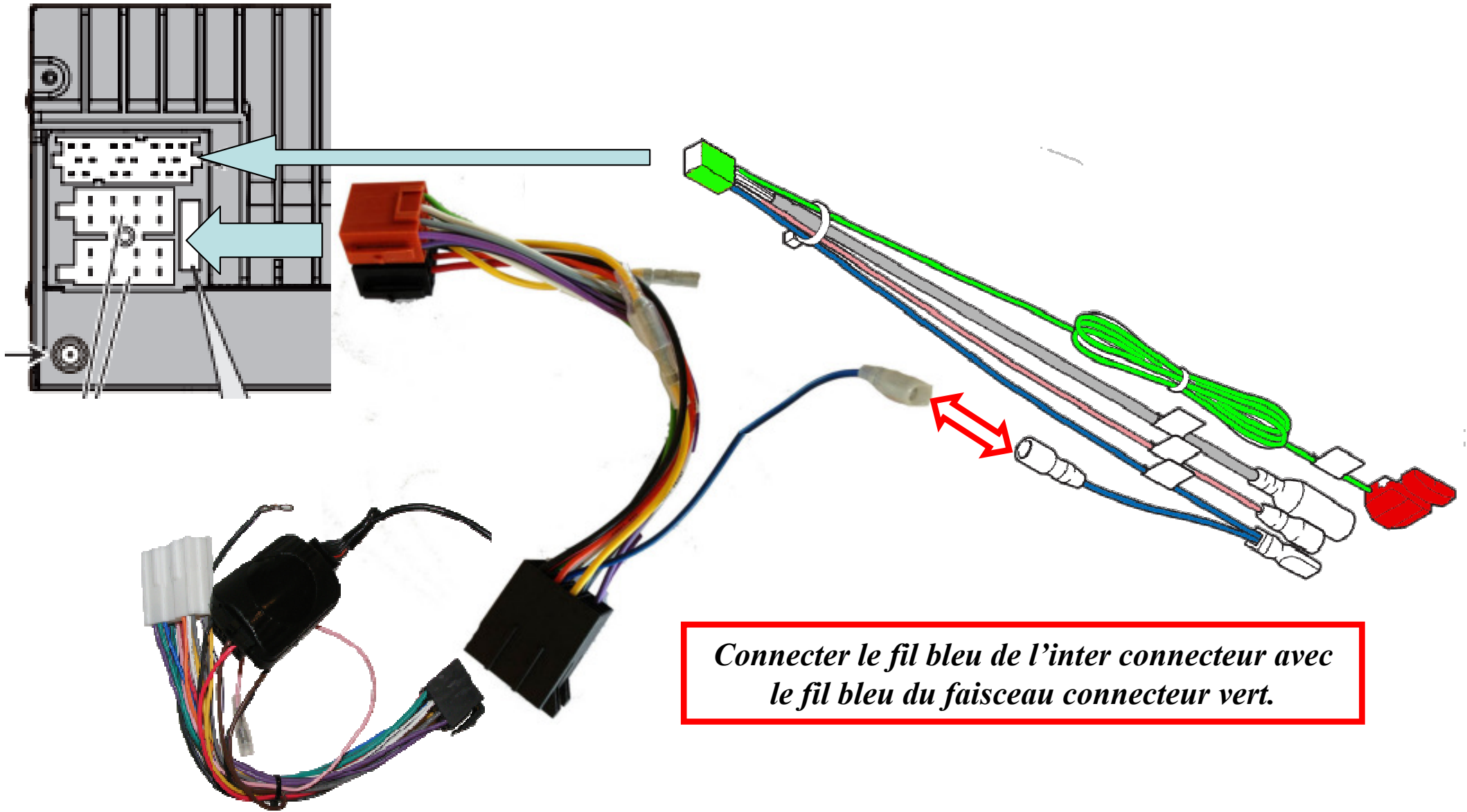

Connecter le fil bleu de l'inter connecteur avec le fil bleu du faisceau connecteur vert.

Préparation du passage du faisceaux caméra

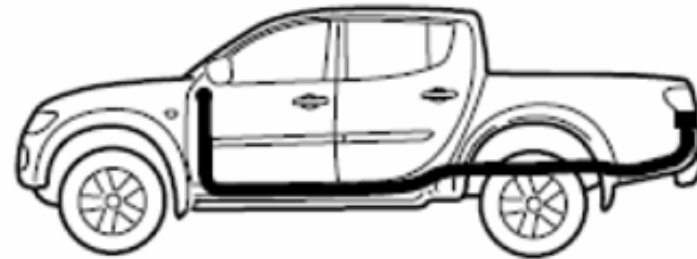
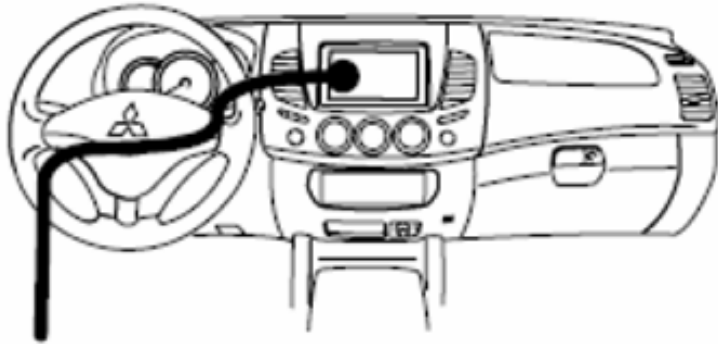
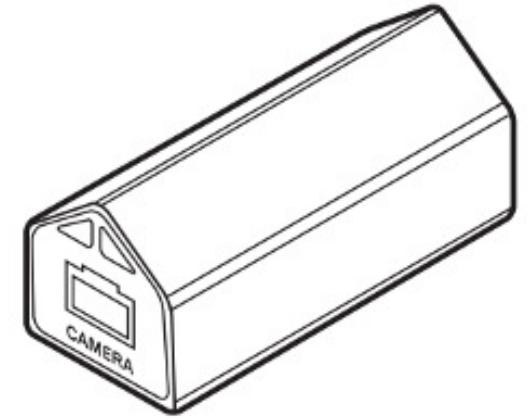
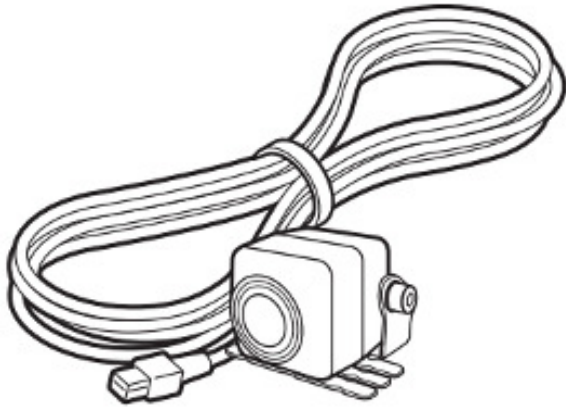

Passage du faisceau caméra

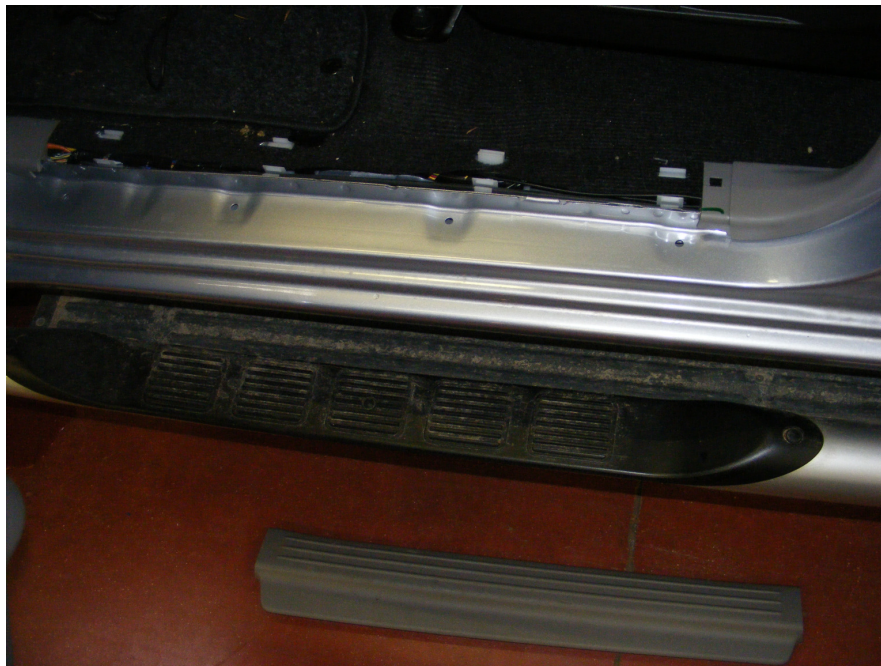
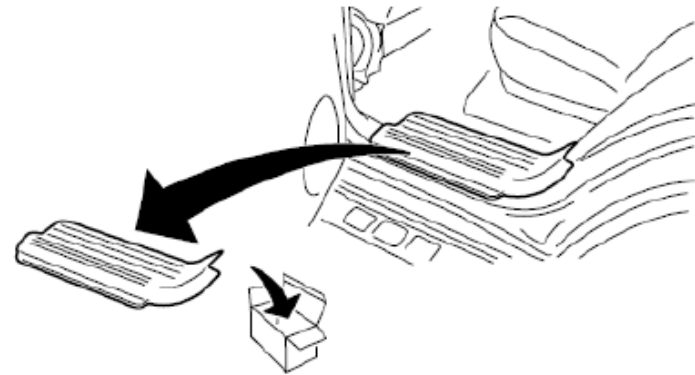
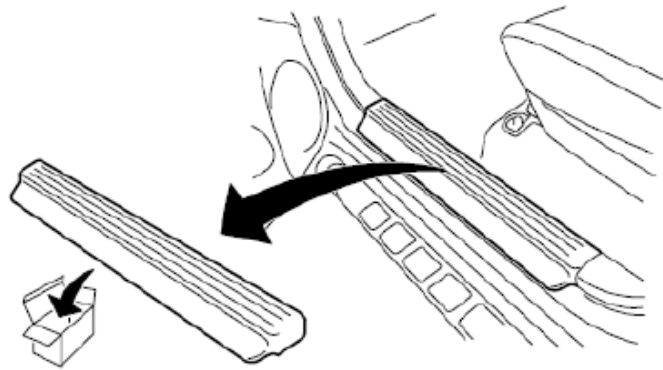

Passage du faisceau caméra

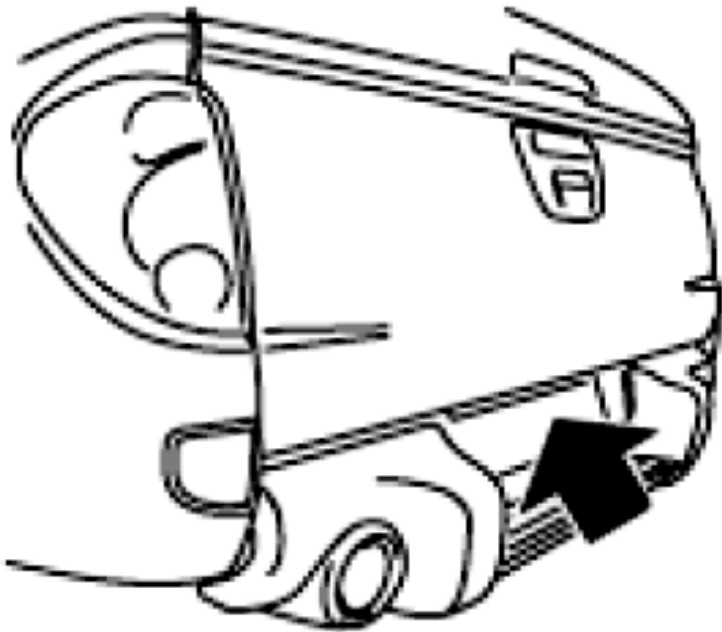
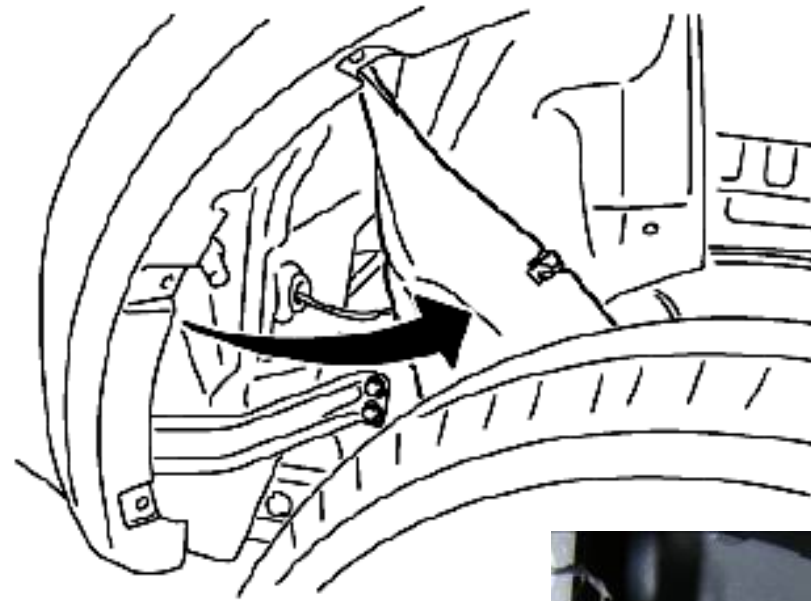
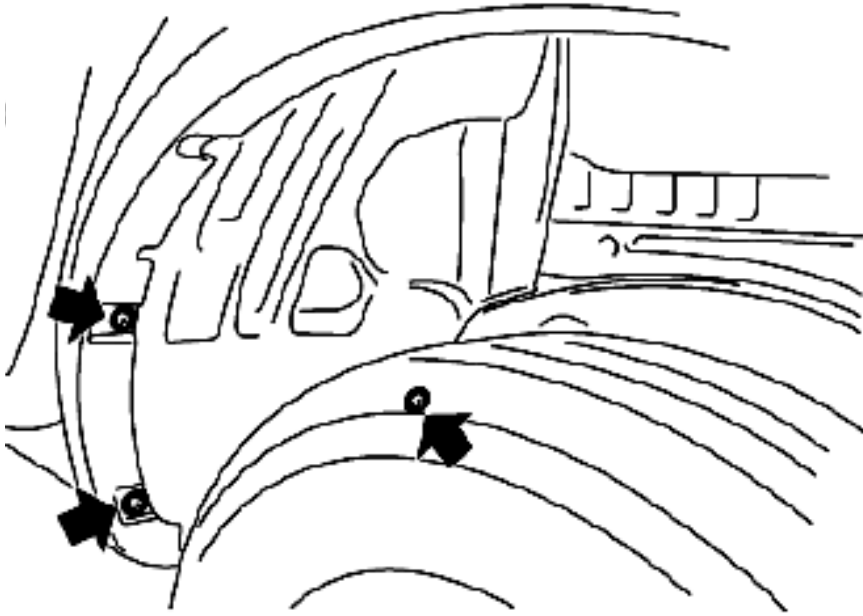

Passage du faisceau caméra

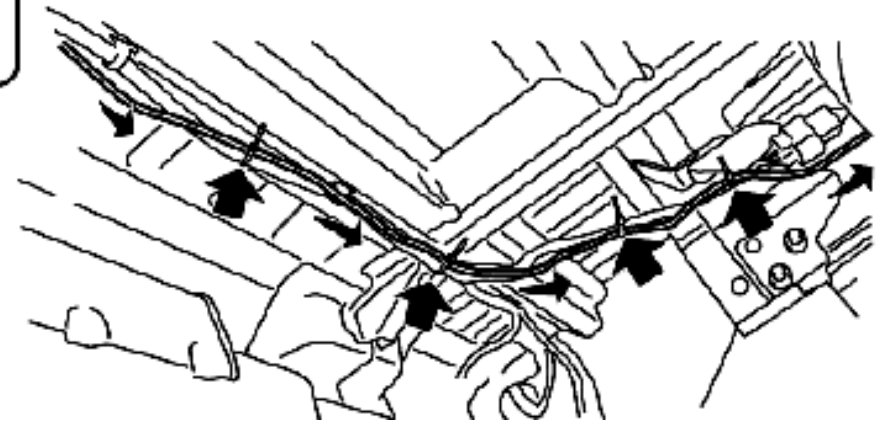
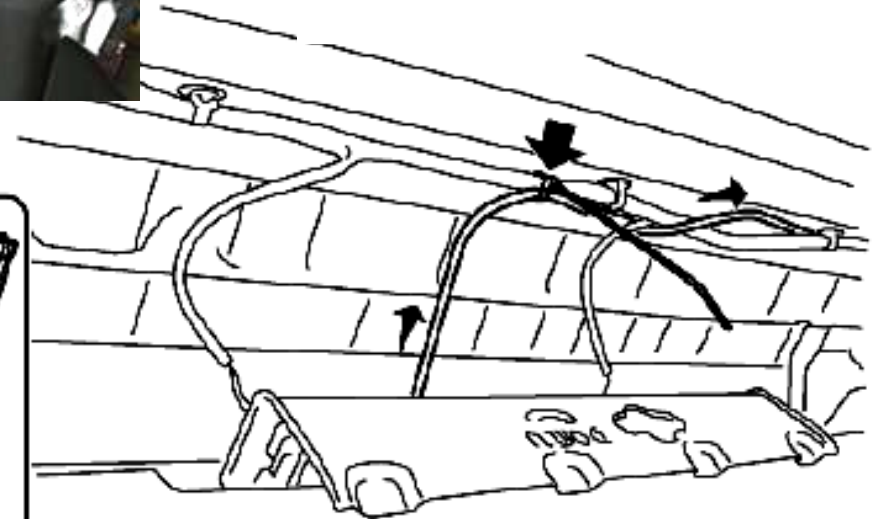
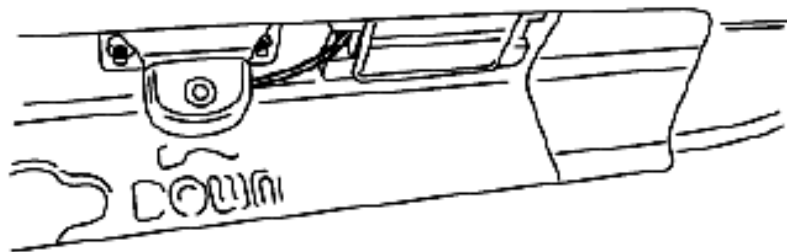
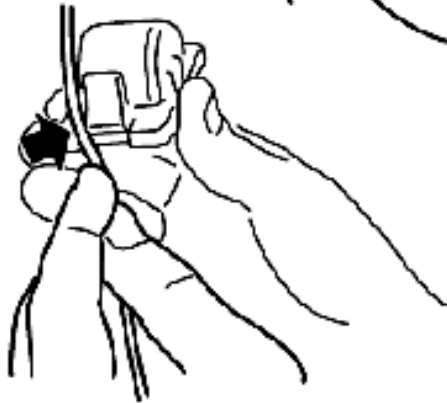
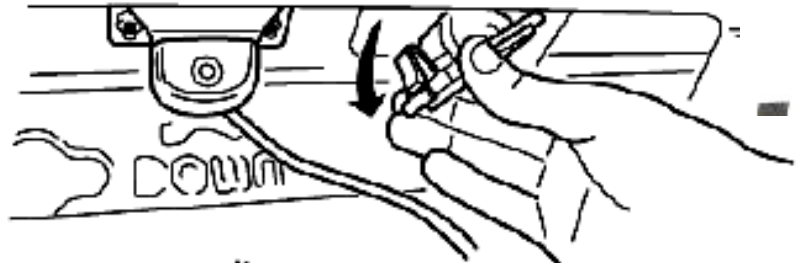
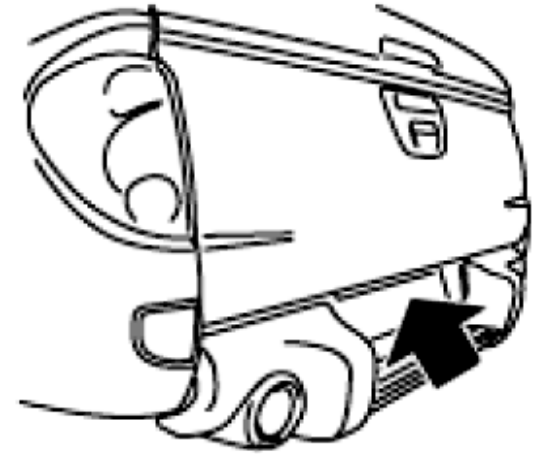

Passage du faisceau caméra

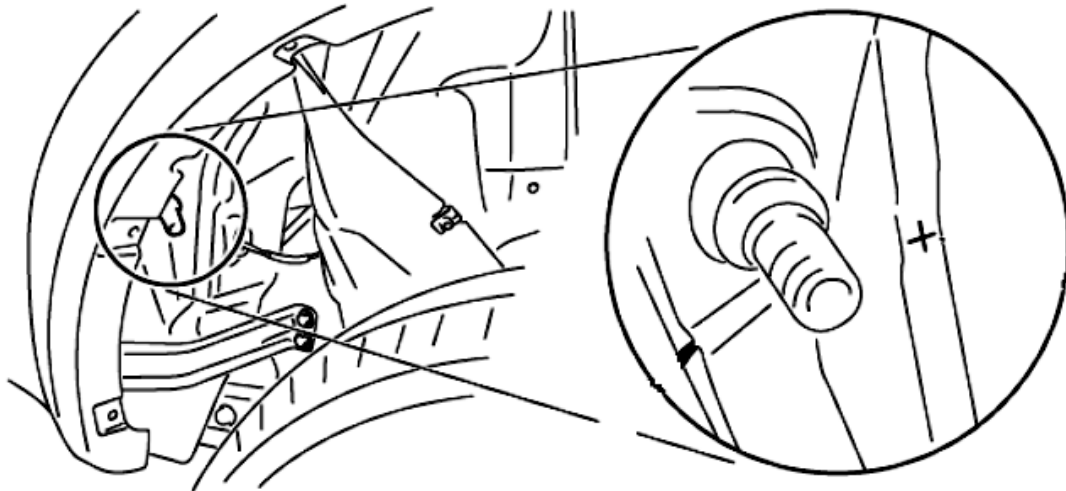
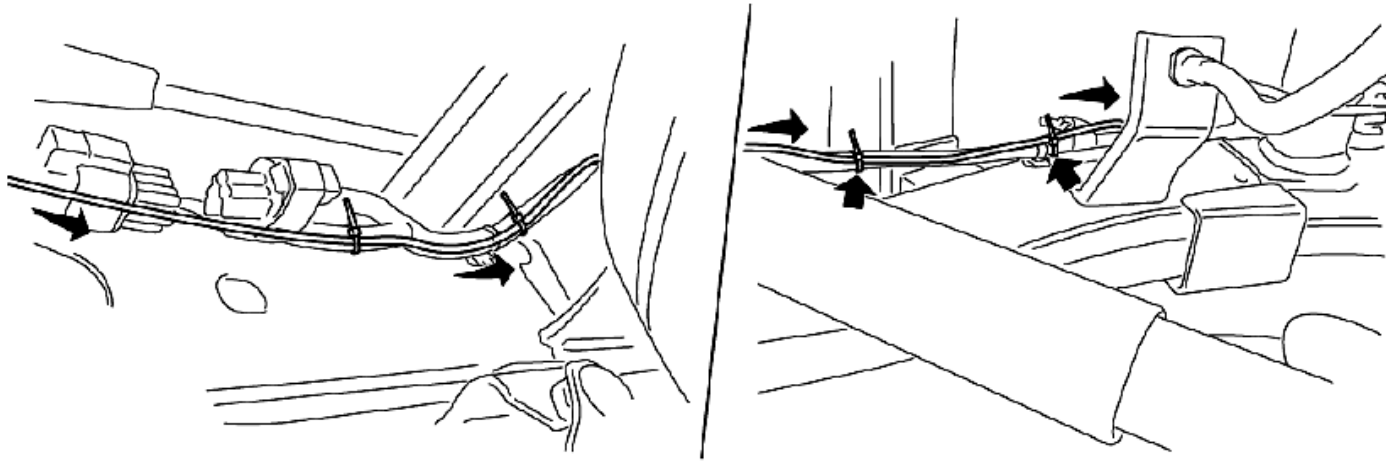
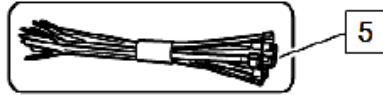

Passage du faisceau caméra

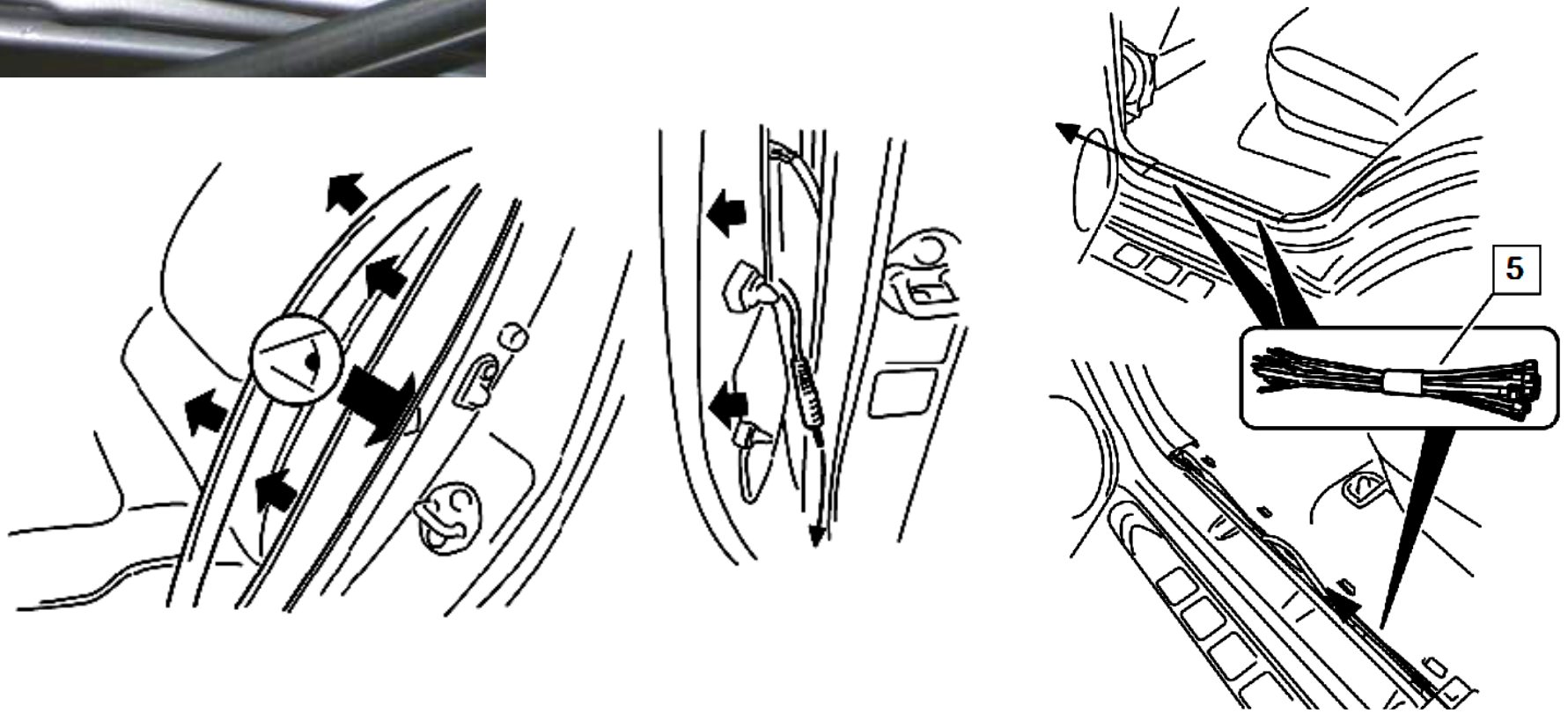

Branchement du faisceau caméra

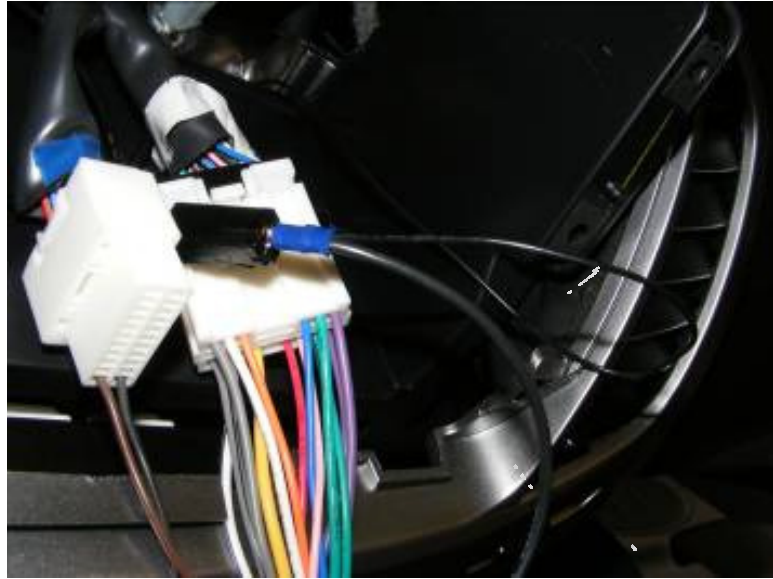

Connecter l'Y sur le fil rouge de l'inter connecteur puis connecter le fil rouge de la caméra sur l'Y avec l'embout rond à sertir

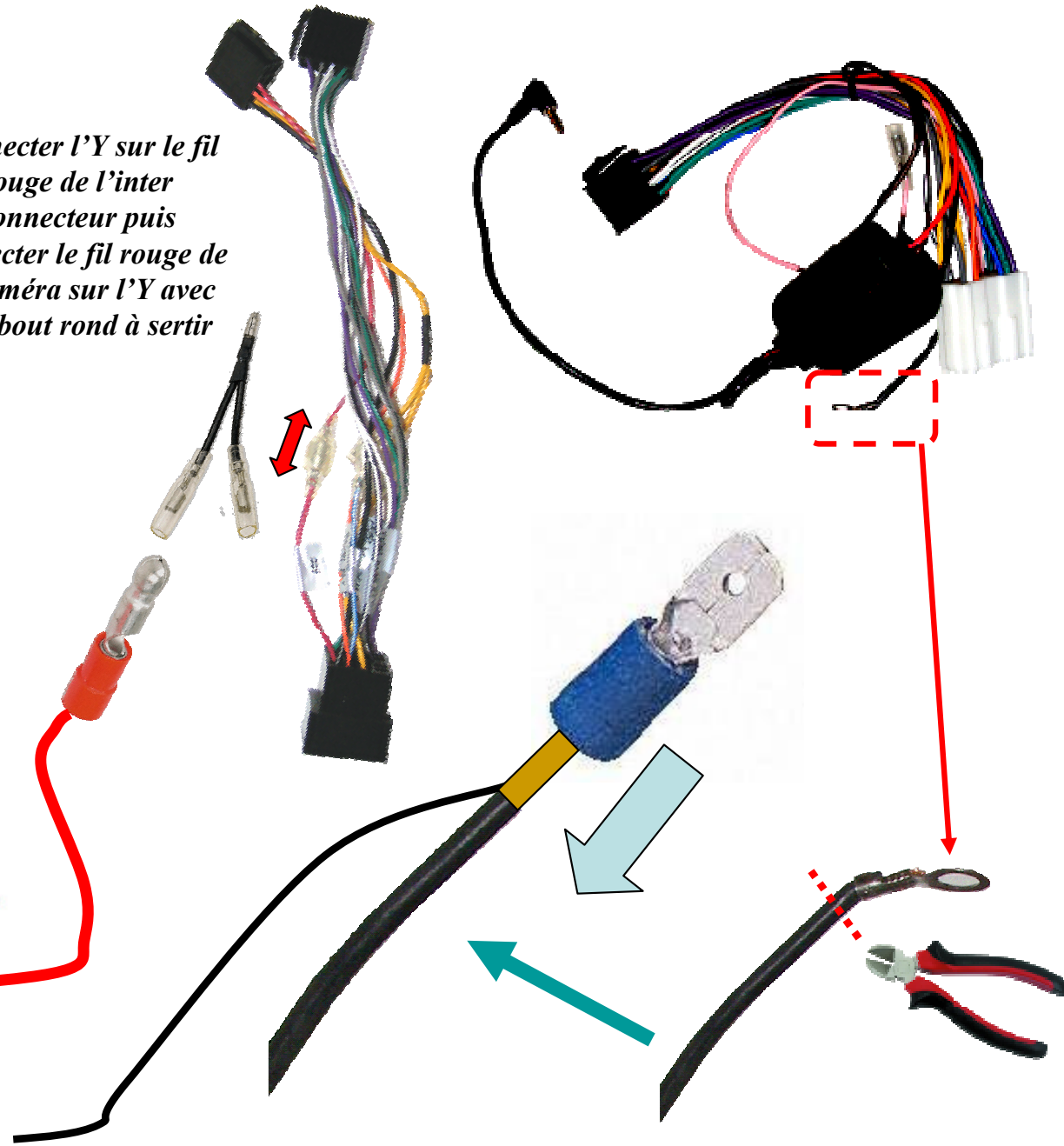
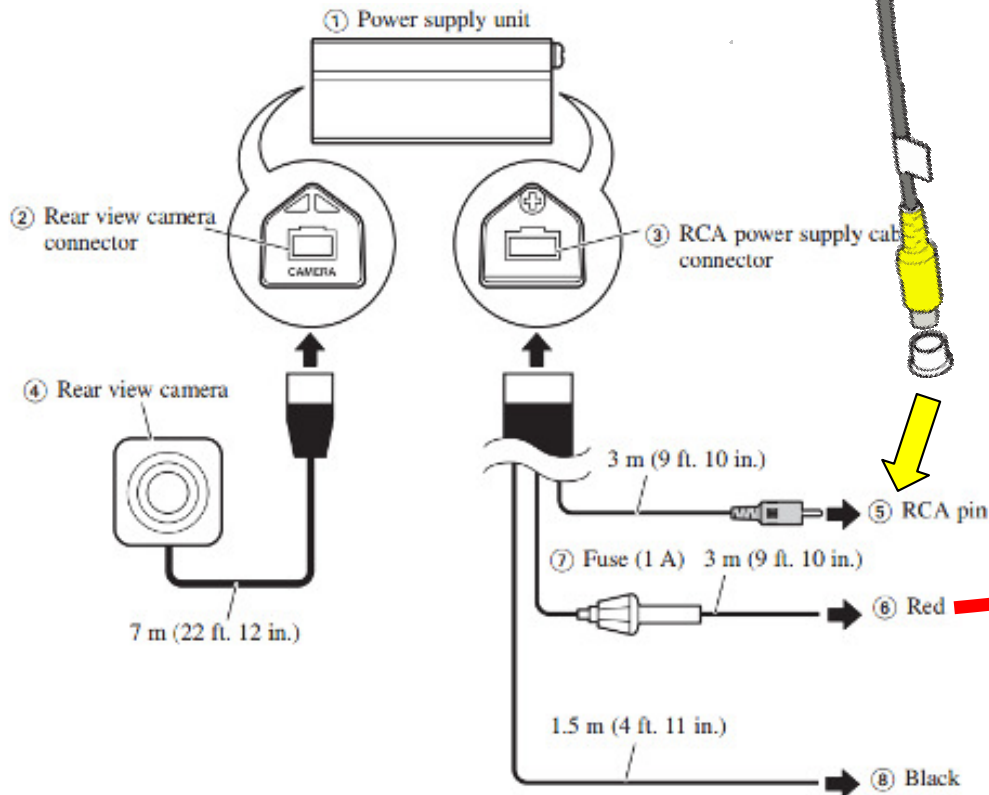

Préparation de l'autoradio.

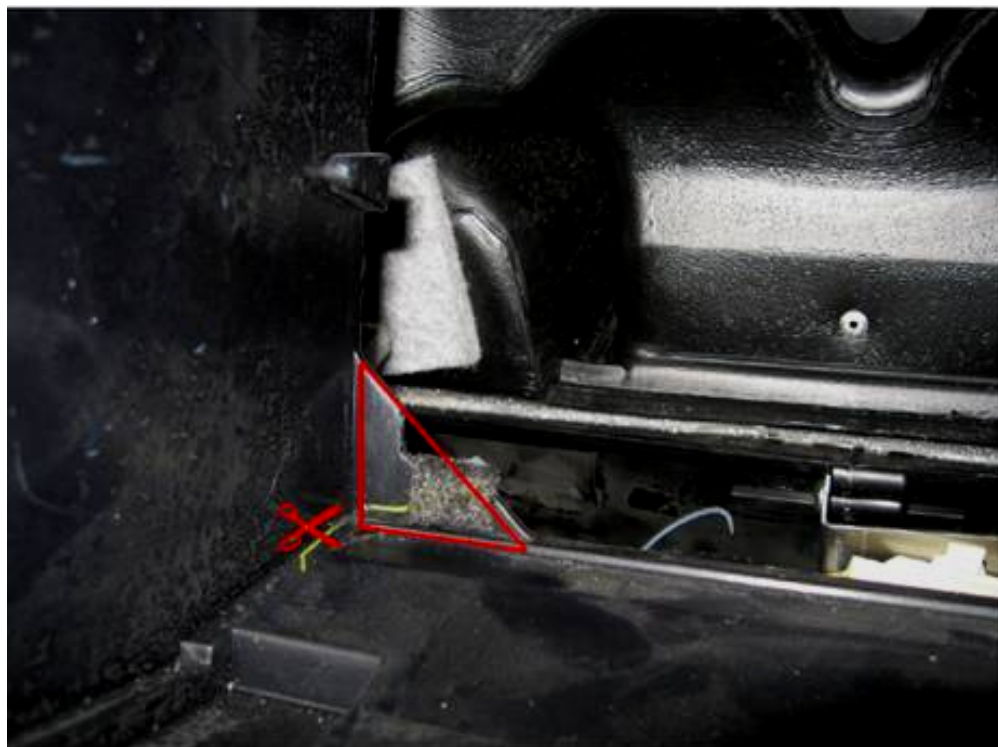

Couper la zone rouge



Préparation de l'autoradio.

Consignes importantes de montage



Retirer les vis de blocage mécanique CD avant installation.

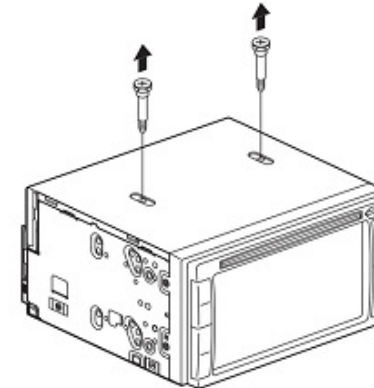

Connecter l'adaptateur ISO/ISO avant tout branchement !
Le câble CD-CW-550 doit absolument être connecté à l'AVIC-F550BT-RT,
y compris avec une interface commande au volant.

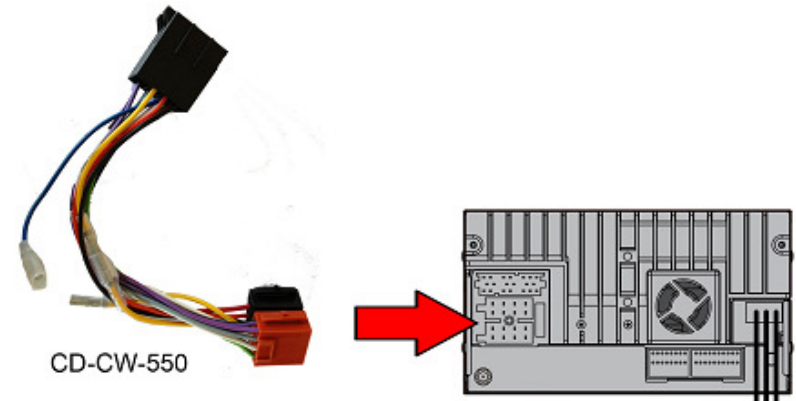

Préparation de l'autoradio.

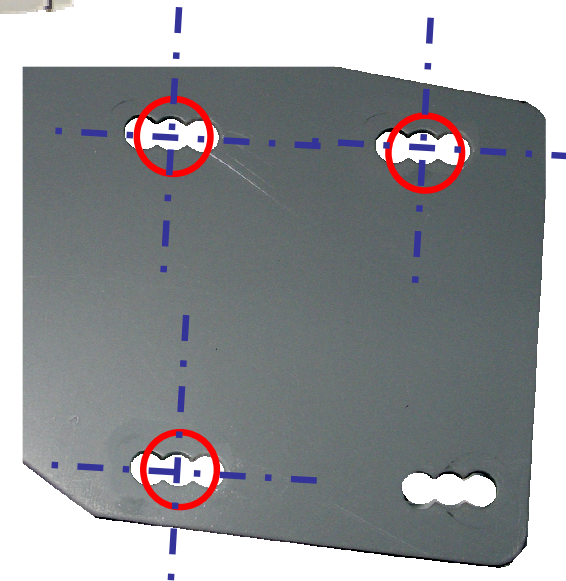
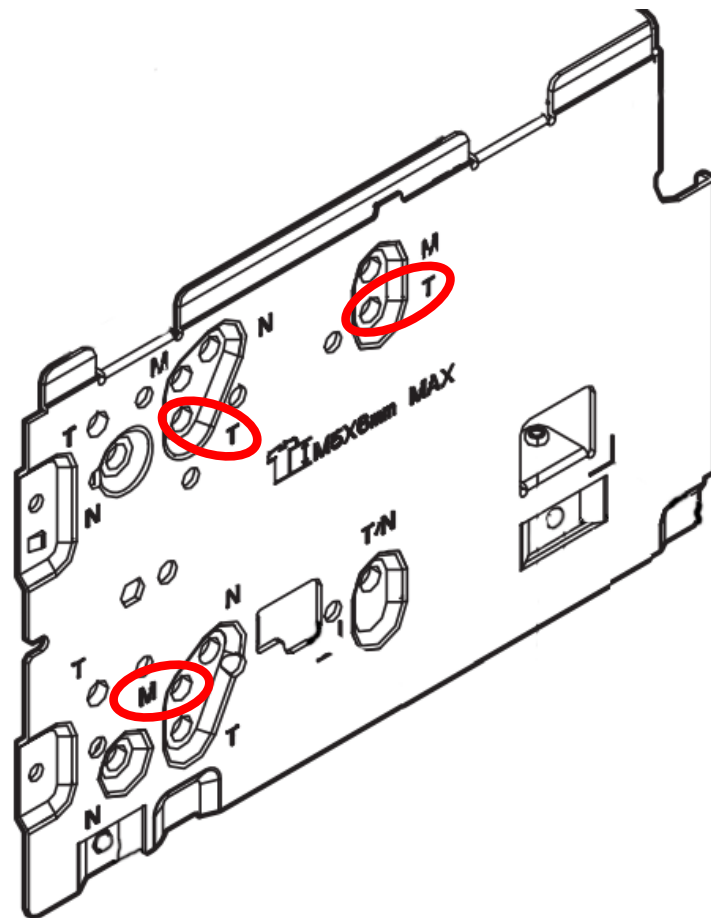
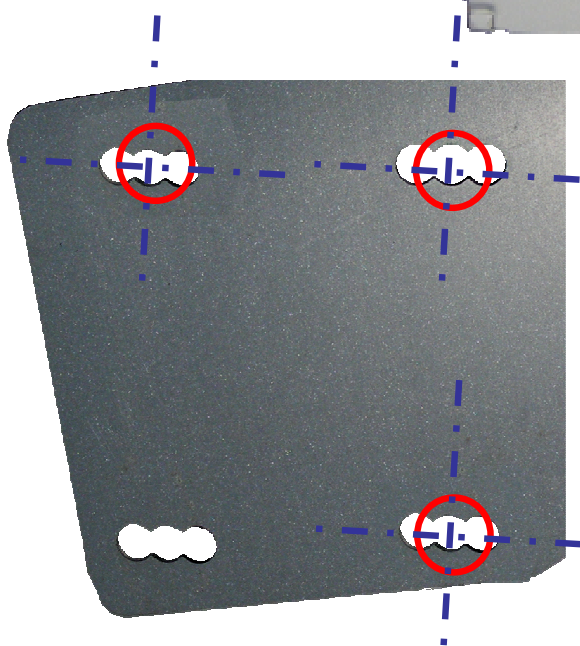
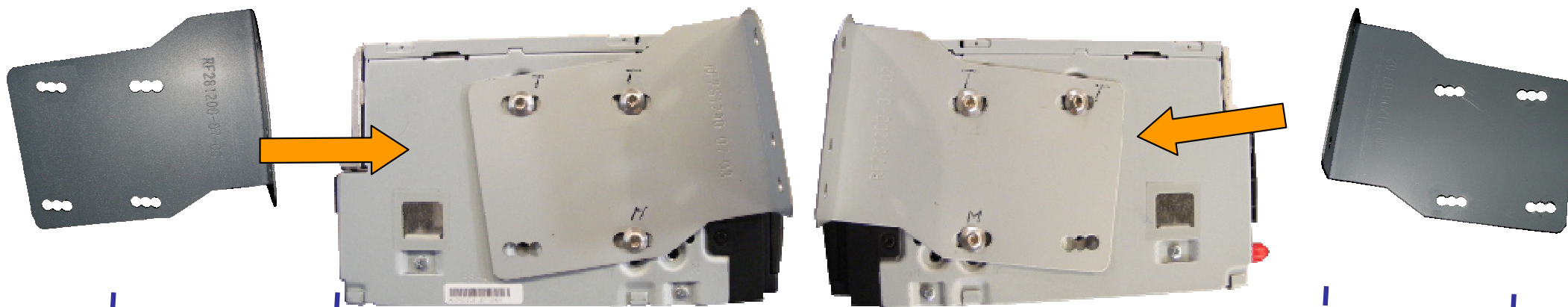

Fixer les deux pattes de montage avec les vis en utilisant les repères T, T et M de l'autoradio



Fixation de l'autoradio.

Positionner la navigation / La fixer avec les quatre vis.

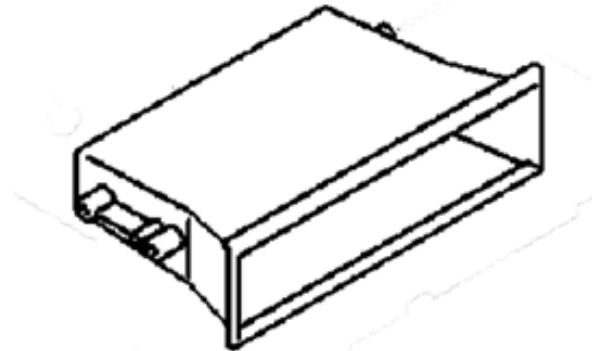



Remontage des caches

Clipser la casquette plus le cadre sur l'ensemble navigation.

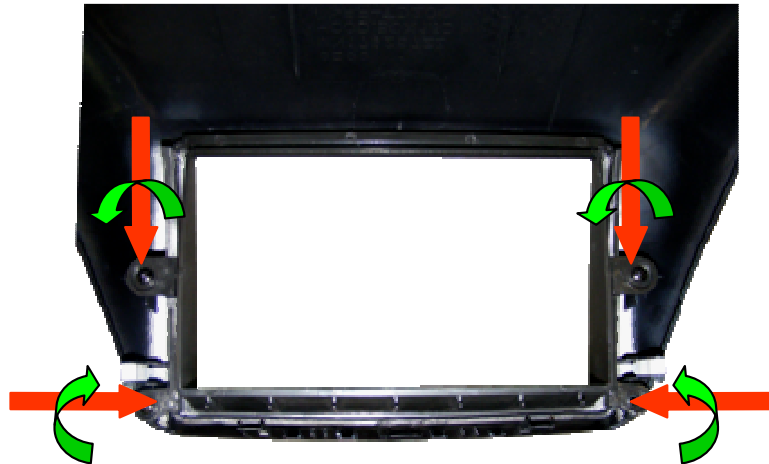
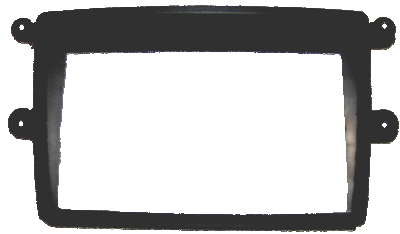

Réglages et configuration .

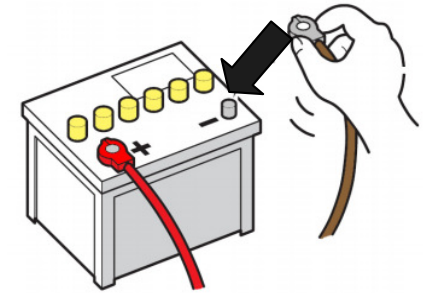

Rebrancher le câble négatif de la batterie

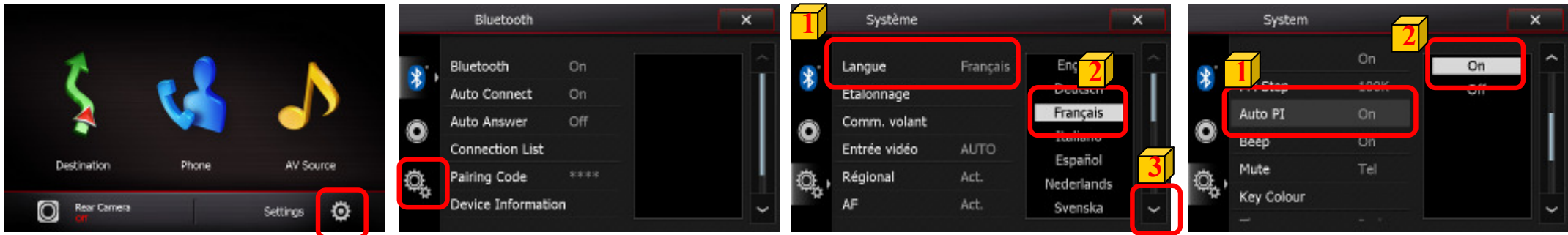

Modification du fond' écran

Éjection d'une carte microSD

1 Appuyez délicatement au centre de la carte microSD jusqu'au dé clic.



2 Tirez tout droit sur la carte microSD pour la sortir.



Insérer la carte micro SD du coffret de configuration pour changer le fond 'écran et la couleur des touches

Insertion d'une carte microSD

● Insérez une carte microSD dans la fente de carte SD.

Insérez la carte microSD avec les contacts de la borne vers le bas et poussez sur la carte jusqu'à ce que vous entendiez un dé clic et qu'elle soit complètement verrouillée.



Réinsérer la carte micro SD cartographique dans la navigation Pioneer

