

## Steering wheel control interface (additional accessory) menu set up



The Interface has various functions so here is a list of them all:

- **Press Wheel IN/SRC** - Enter Menu & Select once in Menu & SOURCE in Radio operation.
- **VOL +/-VOL** - Works just the same
- **Wheel UP/DOWN** - navigate menu up/down & seek up/down in Radio operation
- **HANG-UP/MUTE** - Back in menu & Mute in Radio operation

### Settings

Time Date  
Vehicle Settings  
Logo Select

This is the first screen of the menu, you can make any selection you wish from here.

### Settings

Time Date  
Vehicle Settings  
Logo Select

Now if you press DOWN on the wheel the highlighted item will change to the one below.

### Settings

Time Date  
Vehicle Settings  
Logo Select

**LOGO SELECT** on the menu is the one that is required.

### Settings

● Kenwood  
○ Vauxhall  
○ Opel

Press **IN** on the SRC/WHEEL to go into the **LOGO SELECT** settings.

### Settings

○ Kenwood  
○ Vauxhall  
● Opel

Now you can scroll **UP/DOWN** on the SRC/WHEEL to select the required setting you want to appear on the display.

### Settings

Time Date  
Vehicle Settings  
Logo Select

Once you have selected the option you require then to go back to the main menu you press **PHONE HANG-UP/MUTE**, this will return you to the previous menu.

The same actions are applied to whatever menu you wish to change.

## Installation Manual Double DIN Kit

### • Opel Astra (J) 2010->

#### Double DIN Kit contents

- (1) Facia Plate
  - (2) Mounting Bracket Left
  - (3) Mounting Bracket Right
  - (4) Fixing screws
- additional accessories:**
- (5) Speaker (additional accessory)
  - (6) Stalk Interface (additional accessory)
  - (7) Lead Cable (additional accessory)

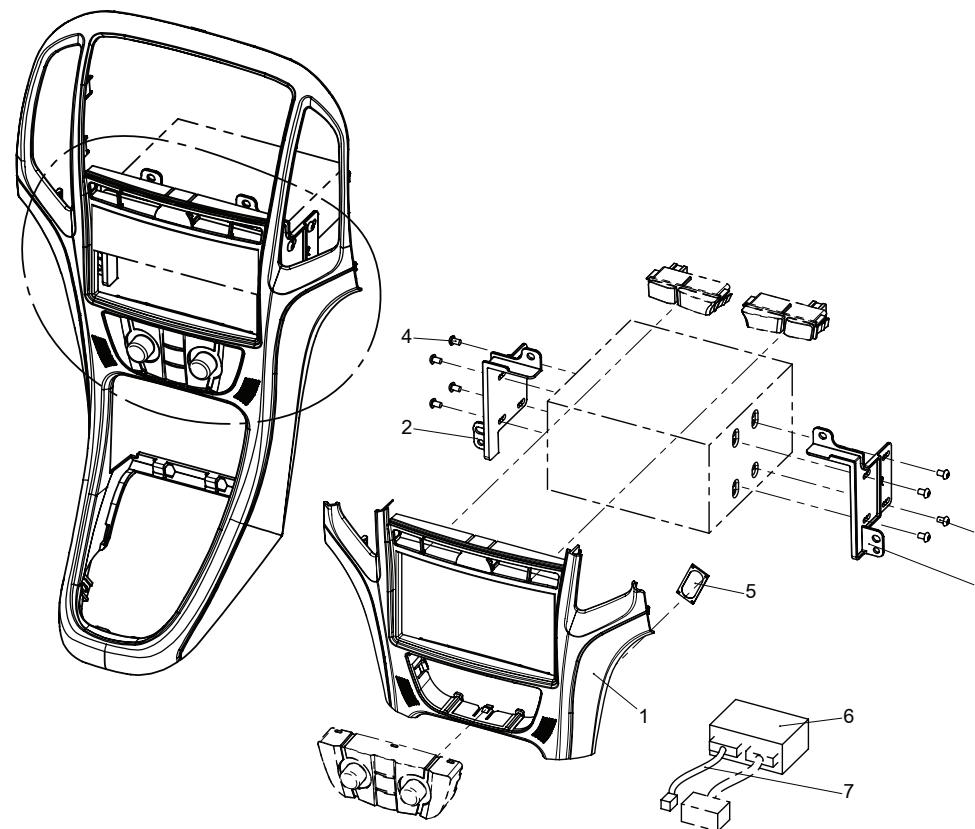



1. Unclip gear shift cover

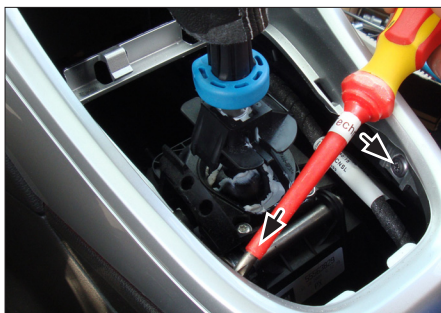

2. Remove screws of OEM center panel



3. Unclip OEM center panel  
Remove OEM center panel

Steering wheel control interface install guide (additional accessory!)

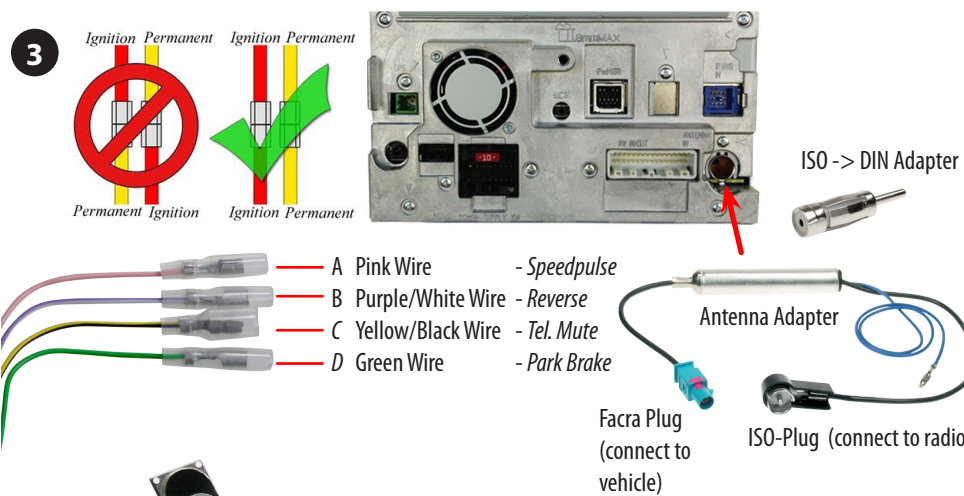
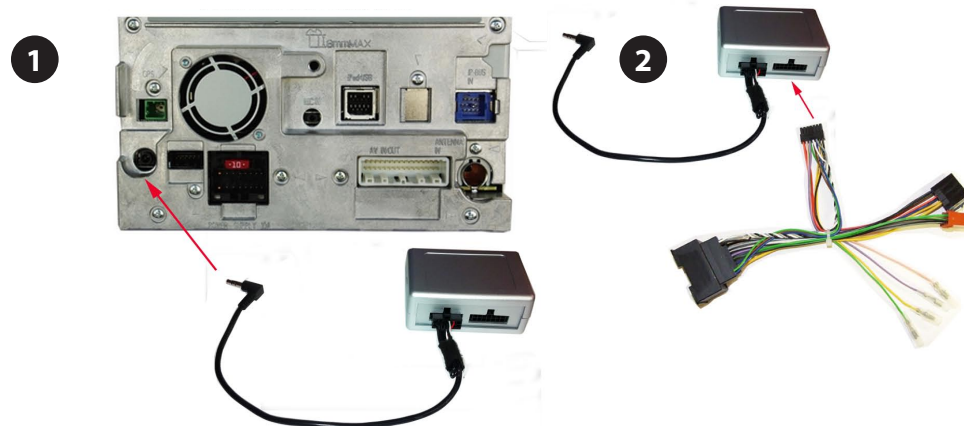

- A Pink Wire - Speedpulse
- B Purple/White Wire - Reverse
- C Yellow/Black Wire - Tel. Mute
- D Green Wire - Park Brake

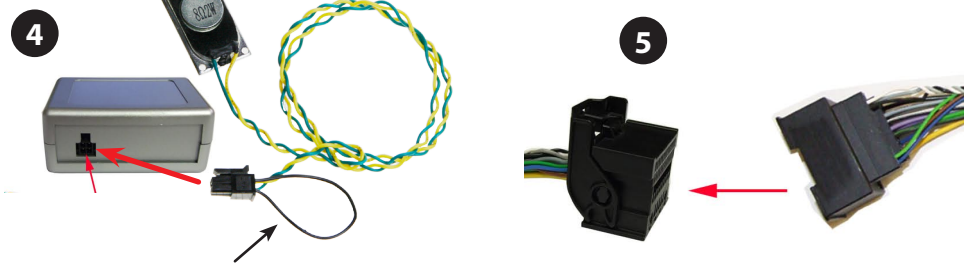

A - vehicles with 4 line dash display only:  
**Cut and insulate this (black) loop**  
B - Connect speaker to slot in facia plate

Vehicle Plug interface connector



15. Cut away top of cigarette lighter unit: along the dashed line.

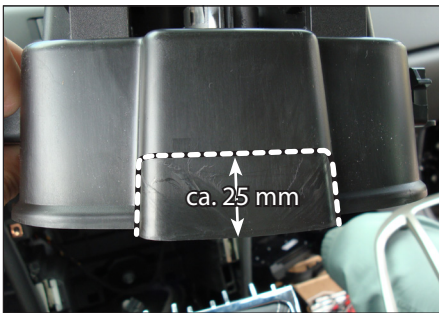

16. Top view of cigarette lighter unit: cut along the dashed line

Caution: measure before you cut!

Reinstall cigarette lighter unit



17. Place facia plate  
Reinstall everything in reverse order to finish installation



4. Remove cigarette lighter unit.

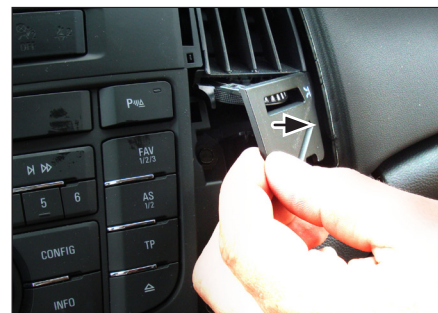

5. Open cover below air vent (left and right)



6. Remove screws of OEM control unit  
Remove OEM control unit

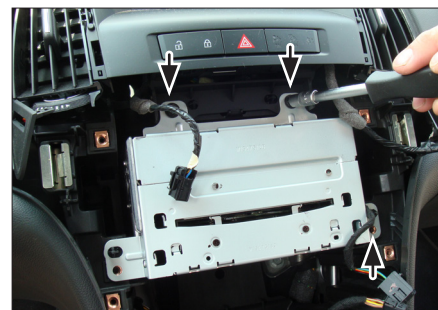

7. Remove screws of OEM head unit  
Remove OEM head unit

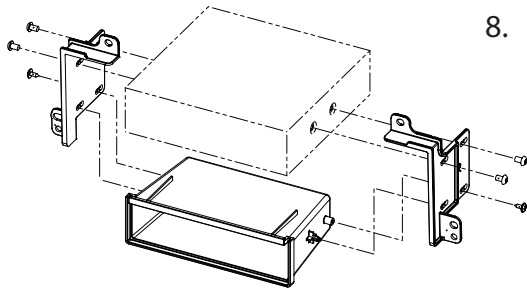

8. **1-DIN radio:**

Attach mounting brackets to double DIN head unit

Fix them with four screws

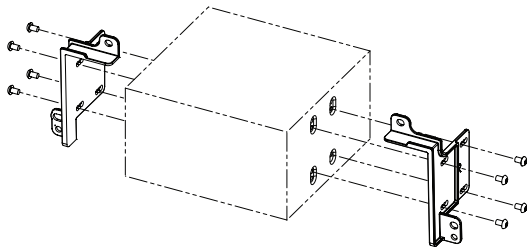

**2-DIN navigation:**

Attach mounting brackets to double DIN head unit

Fix them with four screws

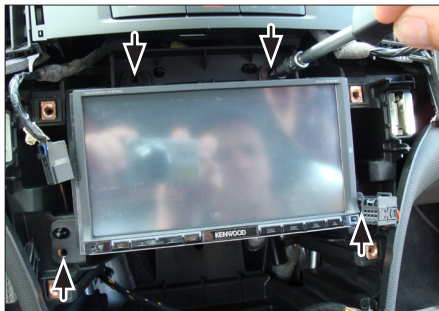

9. Connect steering wheel control interface (see page 7)

*Go to page 7 for a detailed installation guide of steering wheel control interface*

Fix double DIN head unit



10. Unclip air condition control unit from OEM panel

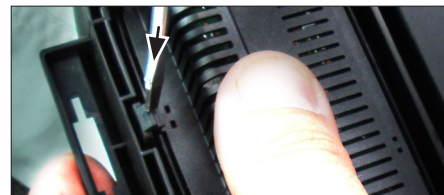

11. Mount air condition control unit to fascia plate

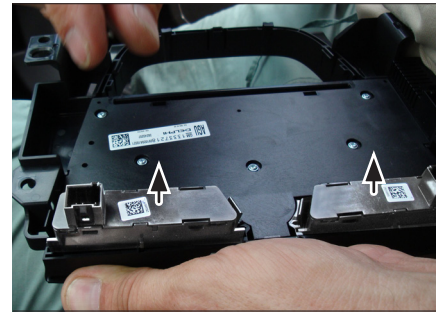

12. Remove switch left and switch right from OEM unit

13. Mount switches to fascia plate

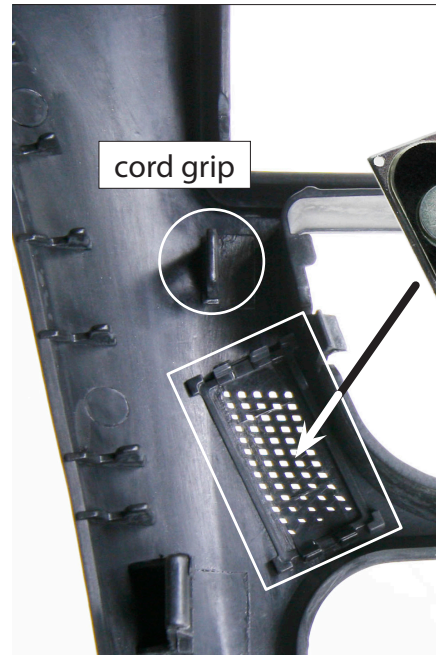

14. Connect speaker\* plug to steering wheel interface. Mount speaker to fascia plate. Use cord grip for securing speaker cable

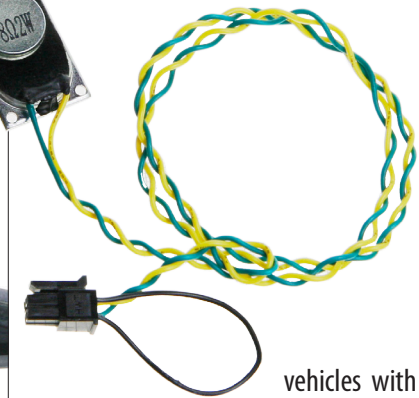

vehicles with 4 line dash display only: Cut and insulate this (black) loop

*\*additinal accessory*